

BBT Automotive Components GmbH

BBT hat sich im Verlauf von 2 Jahrzehnten durch Qualität, Wettbewerbsfähigkeit, Kompetenz und Zuverlässigkeit im Ersatzteilmarkt als starke Marke etabliert.

BBT ist ständig im Einsatz, um Kunden freundlich und fachkundig zu betreuen sowie mit aktuellen Produktinformationen zu versorgen. Dabei stehen termingerechte Lieferungen und einwandfreie Qualität immer im Vordergrund.

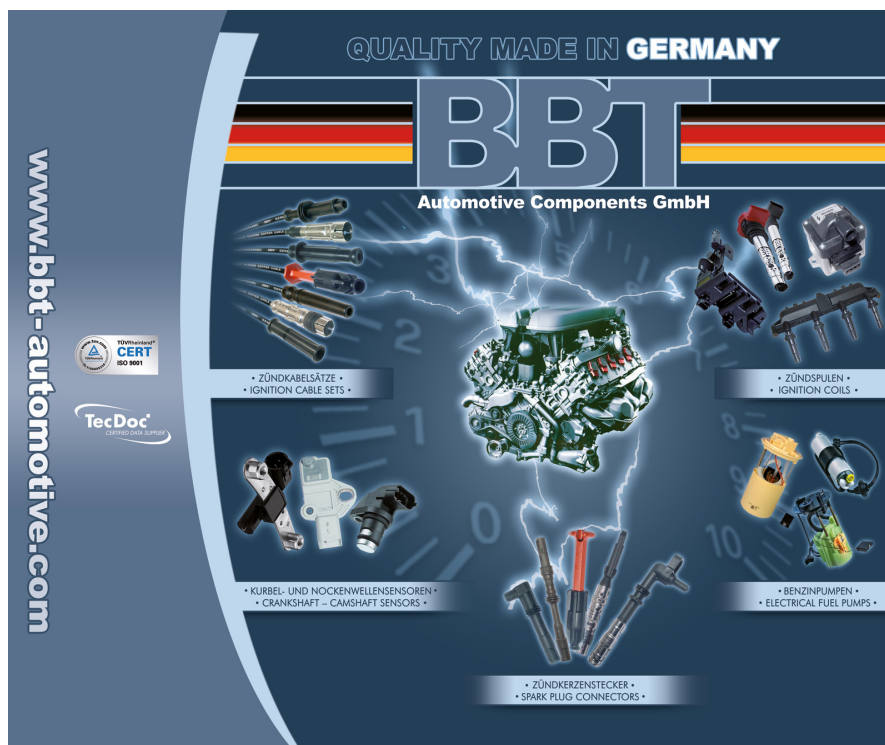

BBT is a strong and well established brand which kept its focus on quality, reliability and competitiveness in the automotive aftermarket during a history of two decades.

BBT is fully committed to provide customers with an excellent service of experts and detailed information about all products. Priority is the product quality along with deliveries on time at competitive prices to serve our customers needs.



Inhaltsverzeichnis

List of Contents

Zündkabelsätze für LPG / CNG

| | | |
|--------------|--------------|--|
| Seite / page | 3 - 4..... | Produktinformation / product information |
| Seite / page | 5 - 14..... | Anwendungsliste / application list |
| Seite / page | 15 - 18..... | Abbildungen / pictures |
| Seite / page | 19 - 20..... | Vergleichsliste / cross reference list |

Allgemeine Informationen

General information

Durch die ständige Weiterentwicklung des Programms ist es möglich, dass sich unsere Produktdaten ändern. BBT Automotive Components GmbH behält sich das Recht vor, Ausführung und Artikelnummern der in diesem Katalog gezeigten Produkte jederzeit und ohne Ankündigung zu ändern. Alle Rechte vorbehalten.

Die Gegenüberstellung von BBT Artikelnummern zu Fahrzeugherstellern oder zu Herstellern von anderen Marken dient zu Vergleichszwecken. Technische Unterschiede sind bauart- und herstellerbedingt möglich, wofür eine Gewährleistung ausgeschlossen ist. Verbindlich bei der Bestellung ist jeweils die BBT Artikelnummer.

Due to continued research and development of our program, BBT Automotive Components GmbH reserves the right to modify all product data without further notice. All rights reserved.

The cross-reference of BBT article numbers to car manufacturers or manufacturers of other brands is only for comparative purposes. Technical differences may occur in relation to construction and manufacturer, therefore warranty can not be granted. When placing the order, the BBT article number is binding.

Bei Rückfragen stehen wir Ihnen gerne jederzeit zu Ihrer Verfügung.
In case of queries do not hesitate to contact us.



Headquarters

BBT Automotive Components GmbH
An der Steinleiten 1
91590 Bruckberg
Germany
Info@bbt-automotive.de
Phone: +49(0)9824 - 9200 0
Fax: +49(0)9824 - 9200 92

Zündkabelsätze für LPG / CNG

Der Trend zum Gaskraftstoff steigt stetig an. Immer mehr Autofahrer lassen ihr Fahrzeug auf den Betrieb mit Autogas umrüsten. Die Gründe dafür sind: günstigere Betriebskosten, sparsame Antriebsart, ausgebautes Tankstellennetz und umweltschonend. Der Gasbetrieb birgt jedoch häufig Probleme, wie Mischungsverhältnis des LPG-Gases, keine Abstimmung zwischen Motor und Gas, höhere Temperaturen, stärkere Belastung der Zündleitungen und Zündspulen als bei Benzinbetrieb.

BBT Zündleitungssätze haben für die meisten Gasmotoren einen metallischen Leiter, der sowohl einen elektrischen Widerstand als auch eine elektrische Induktivität aufweist. Die Zündleitungen liefern somit einen höheren Zündstrom an die Zündkerze.

Die Zündleitungen sind so konzipiert, dass die Phasenverschiebung zwischen Strom und Spannung im Zündfunken minimiert und die Funkenleistungsausbeute maximiert wird.

Umfangreiche Untersuchungen am Motorprüfstand haben gezeigt, dass die Technologie der BBT Zündkabel für Gasmotoren einen Vorteil gegenüber vergleichbaren Zündleitungen darstellen. Ein höherer Funkenstrom erzeugt eine schnellere Verbrennung, wodurch sich ein geringerer Kraftstoffverbrauch und in Folge eine geringere CO₂ Belastung der Atmosphäre ergibt

Das BBT Zündkabelprogramm für LPG (Liquefied Petroleum Gas) und CNG (Compressed Natural Gas) Motoren, umfasst 32 Artikel für 460 verschiedene Fahrzeugmodelle.



Eigenschaften:

- speziell für Monovalent & Bivalent Systeme
- Zündkabel geeignet für Hochtemperaturbetrieb
- Passgenaue Kabellängen und Anschlüsse
- beste Isolation gegen Flüssigkeiten
- hochwertiges Zweilagigen-Silikon Zündkabel
- Made in Germany
- schnellere Verbrennung
- geringerer Kraftstoffverbrauch
- CO₂-sparend

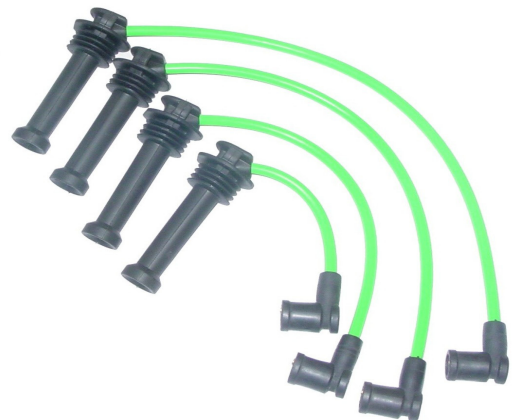

Ignition Cable Sets for Gas Engines

The trend for natural gas fuel is steadily increasing. More and more car drivers let their cars re-equip for natural gas, by the following reasons: less operating costs, the economical way of drive, a well-built petrol station network environmentally friendly. However, a natural gas drive involves also problems like the mixture of LPG gas, no adjustment between engine and gas, higher temperatures and impact on the ignition cables and ignition coils, compared to petrol-fuelled vehicles.

Therefore, BBT offers ignition cables with a metallic conductor for the most gas vehicles which acts as a resistor and an inductor at the same time, to create an internal resonating circuit. This provides a strong and powerful spark current to the spark plug.

The BBT spark plug cables for natural gas engines are built in such a way, that the phase shift is minimized in order to achieve maximum electrical power to the spark.

Extensive research in the laboratory and on the engine dynamometer has shown that the BBT spark plug cables for natural gas engines are superior to other spark plug cables. A spark with higher electrical current causes faster combustion, lower fuel consumption and, as a consequence, the CO₂ emission to the atmosphere is reduced.

The BBT range of ignition cables for LPG (Liquefied Petroleum Gas) and CNG (Compressed Natural Gas) engines, includes 32 items for 460 different vehicles.



Advantages:

- Especially for mono-fuel and bi-fuel systems
- Ignition cables suitable for high temperature
- Exact cable lengths and connectors
- High-quality two-layer silicone ignition cable
- Made in Germany
- Faster combustion
- Less fuel consumption
- Less CO₂ emission

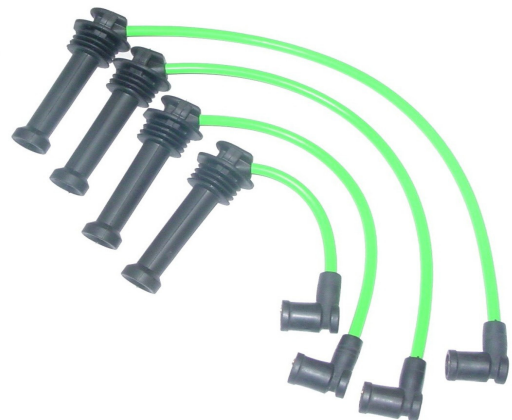

| Typ Type | Motornummer Engine-No. | Baujahr Year | Liter Litre | Zyl. Cyl. | KW | Vert. Distr. | BBT-Nr. BBT-No. | Abb. Pict. |
|-----------------------|----------------------------|-----------------|----------------|--------------|-----|-----------------|--------------------|---------------|
| Audi | | | | | | | | |
| A1 1.2 TFSI | CBZA | 05.10 -> | 1,2 | 4 | 63 | M4 | ZKG0314 | 001 |
| A1 1.2 TFSI Sportback | CBZA | 01.12 -> | 1,2 | 4 | 63 | M4 | ZKG0314 | 001 |
| A3 1.2 TFSI Cabriolet | CBZB | 03.10 -> | 1,2 | 4 | 77 | M4 | ZKG0314 | 001 |
| A3 1.2 TSI | CBZB | 04.10 -> | 1,2 | 4 | 77 | M4 | ZKG0314 | 001 |
| A3 1.2 TSI Sportback | CBZB | 04.10 -> | 1,2 | 4 | 77 | M4 | ZKG0314 | 001 |
| A3 1.6 | AEH, AKL, APF | 09.96 - 08.00 | 1,6 | 4 | 74 | M4 | ZKG0359 | 003 |
| A3 1.6 | BGU, BSE, BSF, CCSA | 05.03 -> | 1,6 | 4 | 75 | M4 | ZKG3000 | 025 |
| A3 1.6 Cabriolet | BSE | 09.08 -> | 1,6 | 4 | 75 | M4 | ZKG3000 | 025 |
| A3 1.6 Sportback | BGU, BSE, BSF, CCSA | 09.04 -> | 1,6 | 4 | 75 | M4 | ZKG3000 | 025 |
| A4 1,6 | ALZ | 07.00 - 11.00 | 1,6 | 4 | 75 | M4 | ZKG0359 | 003 |
| A4 1.6 | ADP, AHL, ANA, ARM | 01.95 - 07.00 | 1,6 | 4 | 74 | M4 | ZKG0359 | 003 |
| A4 1.6 | ALZ | 11.00 - 12.04 | 1,6 | 4 | 75 | M4 | ZKG0359 | 003 |
| A4 1.6 | ALZ | 11.04 -> | 1,6 | 4 | 75 | M4 | ZKG0359 | 003 |
| A4 2.4 | AGA, ALF, AML, APS, ARJ | 03.97 - 11.00 | 2,4 | 6 | 121 | M4 | ZKG0357 | 002 |
| A4 2.4 | AJG, AMM, APZ | 08.97 - 11.00 | 2,4 | 6 | 120 | M4 | ZKG0357 | 002 |
| A4 2.4 | AMM | 09.01 - 12.04 | 2,4 | 6 | 120 | M4 | ZKG0357 | 002 |
| A4 2.4 Avant | AGA, ALF, AML, APS, ARJ | 03.97 - 09.01 | 2,4 | 6 | 121 | M4 | ZKG0357 | 002 |
| A4 2.4 Avant | AJG, AMM, APZ | 08.97 - 09.01 | 2,4 | 6 | 120 | M4 | ZKG0357 | 002 |
| A4 2.4 Cabriolet | AMM | 04.02 - 12.05 | 2,4 | 6 | 120 | M4 | ZKG0357 | 002 |
| A4 2.4 Cabriolet | BDV | 04.02 - 12.05 | 2,4 | 6 | 125 | M4 | ZKG0357 | 002 |
| A4 2.4 Quattro | AGA, ALF, AML, APS, ARJ | 03.97 - 11.00 | 2,4 | 6 | 121 | M4 | ZKG0357 | 002 |
| A4 2.4 Quattro | APZ | 03.97 - 11.00 | 2,4 | 6 | 120 | M4 | ZKG0357 | 002 |
| A4 2.8 | ACK, ALG, AMX, APR, AQD | 10.96 - 11.00 | 2,8 | 6 | 142 | M4 | ZKG0357 | 002 |
| A4 2.8 Avant | ACK, ALG, AMX, APR, AQD | 10.96 - 11.00 | 2,8 | 6 | 142 | M4 | ZKG0357 | 002 |
| A4 2.8 Quattro | ACK, ALG, AMX, APR, AQD | 10.96 - 11.00 | 2,8 | 6 | 142 | M4 | ZKG0357 | 002 |
| A6 2.0 Avant | ALT | 08.01 - 01.05 | 2,4 | 6 | 96 | M4 | ZKG0357 | 002 |
| A6 2.4 | AGA, ALF, AML, APS, ARJ | 02.97 - 01.05 | 2,4 | 6 | 121 | M4 | ZKG0357 | 002 |
| A6 2.4 | AJG, AMM, APZ | 02.97 - 01.05 | 2,4 | 6 | 120 | M4 | ZKG0357 | 002 |
| A6 2.4 | ALW, ARN, ASM | 07.98 - 01.05 | 2,4 | 6 | 100 | M4 | ZKG0357 | 002 |
| A6 2.4 | APC | 02.97 - 01.05 | 2,4 | 6 | 115 | M4 | ZKG0357 | 002 |
| A6 2.4 | BDV | 08.01 - 01.05 | 2,4 | 6 | 125 | M4 | ZKG0357 | 002 |
| A6 2.4 Quattro | AGA, ALF, AML, APS, ARJ | 02.97 - 01.05 | 2,4 | 6 | 121 | M4 | ZKG0357 | 002 |
| A6 2.4 Quattro | AJG, APZ | 02.94 - 01.05 | 2,4 | 6 | 120 | M4 | ZKG0357 | 002 |
| A6 2.4 Quattro | APC | 08.98 - 07.99 | 2,4 | 6 | 115 | M4 | ZKG0357 | 002 |
| A6 2.4 Quattro | BDV | 08.01 - 01.05 | 2,4 | 6 | 125 | M4 | ZKG0357 | 002 |
| A8 2.8 | ACK, ALG, AMX, APR, AQD | 04.96 - 09.02 | 2,8 | 6 | 142 | M4 | ZKG0357 | 002 |
| A8 2.8 Quattro | ACK, AMX, APR, AQD | 04.96 - 09.02 | 2,8 | 6 | 142 | M4 | ZKG0357 | 002 |
| BMW | | | | | | | | |
| 316 Ci Coupe (E46) | M43 B16 (16 4 E3) | 04.00 -> | 1,6 | 4 | 77 | M4 | ZKG0940 | 007 |
| 316 g Compact (E36) | --- | 12.95 - 08.00 | 1,6 | 4 | 75 | M4 | ZKG0949 | 008 |
| 316 i (E36) | M43 B16 | 07.93 - 02.98 | 1,6 | 4 | 75 | M4 | ZKG0949 | 008 |
| 316 i (E46) | M43 B16, M43 B16 (16 4 E3) | 04.00 - 02.05 | 1,6 | 4 | 77 | M4 | ZKG0940 | 007 |
| 316 i (E46) | M43 B19 TU, M43 16 4 E3 | 09.98 - 02.05 | 1,9 | 4 | 77 | M4 | ZKG0940 | 007 |
| 316 i Compact (E36) | M43 B19 TU, M43 16 4 E3 | 12.98 - 08.00 | 1,9 | 4 | 77 | M4 | ZKG0940 | 007 |
| 316 i Compact (E36) | M43 B16 | 03.94 - 08.00 | 1,6 | 4 | 75 | M4 | ZKG0949 | 008 |
| 316 i Coupe (E36) | M43 B16 | 09.93 - 04.99 | 1,6 | 4 | 75 | M4 | ZKG0949 | 008 |
| 316 i Tooring (E36) | M43 B16 | 01.96 - 10.99 | 1,6 | 4 | 75 | M4 | ZKG0949 | 008 |
| 316 ti Compact (E36) | N42 B18, N46 B18A | 06.01 - 02.05 | 1,8 | 4 | 85 | M4 | ZKG0940 | 007 |
| 318 Ci Coupe (E46) | M43 B19 | 11.99 - 09.01 | 1,9 | 4 | 87 | M4 | ZKG0940 | 007 |
| 318 i (E36) | M43 B18 | 10.93 - 02.98 | 1,8 | 4 | 85 | M4 | ZKG0949 | 008 |
| 318 i (E46) | M43 B19, M43 B19 TU | 02.98 - 09.01 | 1,9 | 4 | 87 | M4 | ZKG0940 | 007 |
| 318 i Cabriolet (E36) | M43 B18 | 01.94 - 04.99 | 1,8 | 4 | 85 | M4 | ZKG0949 | 008 |

| Typ Type | Motornummer Engine-No. | Baujahr Year | Liter Litre | Zyl. Cyl. | KW | Vert. Distr. | BBT-Nr. BBT-No. | Abb. Pict. |
|----------------------|---------------------------|-----------------|----------------|--------------|-----|-----------------|--------------------|---------------|
| 318 i Touring (E36) | M43 B18 | 07.95 - 10.99 | 1,8 | 4 | 85 | M4 | ZKG0949 | 008 |
| 318 i Touring (E46) | M43 B19, M43 B19 TU | 10.99 - 09.01 | 1,9 | 4 | 87 | M4 | ZKG0940 | 007 |
| 318 is (E36) | M44 B19 | 09.95 - 02.98 | 1,9 | 4 | 103 | M4 | ZKG0959 | 009 |
| 318 is (E36) | M42 B18 | 03.93 - 09.97 | 1,8 | 4 | 103 | M4 | ZKG0959 | 009 |
| 318 is Coupe (E36) | M42 B18 | 03.92 - 10.95 | 1,8 | 4 | 103 | M4 | ZKG0959 | 009 |
| 318 is Coupe (E36) | M44 B19 | 09.95 - 04.99 | 1,9 | 4 | 103 | M4 | ZKG0959 | 009 |
| 318 ti Compact (E36) | M42 B18 | 11.94 - 08.95 | 1,8 | 4 | 103 | M4 | ZKG0959 | 009 |
| 318 ti Compact (E36) | M44 B19 | 07.95 - 08.00 | 1,9 | 4 | 103 | M4 | ZKG0959 | 009 |
| 518 g Touring (E34) | M43 B18 | 11.95 - 06.96 | 1,8 | 4 | 85 | M4 | ZKG0940 | 007 |
| 518 i (E34) | M43 B18 | 08.89 - 09.95 | 1,8 | 4 | 85 | M4 | ZKG0940 | 007 |
| 518 i Touring (E34) | M43 B18 | 09.94 - 01.97 | 1,8 | 4 | 85 | M4 | ZKG0940 | 007 |
| Z3 1.8 Cabriolet | M43 B18 | 10.95 - 10.98 | 1,8 | 4 | 85 | M4 | ZKG0949 | 008 |
| Z3 1.9 Cabriolet | M43 B19 TU, M43 B19 TU | 07.98 - 01.03 | 1,9 | 4 | 87 | M4 | ZKG0949 | 008 |
| Z3 1.9 Cabriolet | M43 194 E1 | 01.99 - 01.03 | 1,9 | 4 | 85 | M4 | ZKG0949 | 008 |
| Z3 1.9 Cabriolet | M44 B19 | 10.95 - 03.99 | 1,9 | 4 | 103 | M4 | ZKG0959 | 009 |

Chrysler

| | | | | | | | | |
|------------------------|--------|----------|-----|---|-----|----|---------|-----|
| Aveo 1.2 | --- | 04.08 -> | 1,2 | 4 | 62 | M4 | ZKG1111 | 011 |
| Aveo 1.2 | F12S3 | 03.06 -> | 1,2 | 4 | 53 | M4 | ZKG1111 | 011 |
| Crossfire 3.2 | EGX | 07.03 -> | 3,2 | 6 | 160 | M4 | ZKG0437 | 005 |
| Crossfire Roadster 3.2 | EGX | 05.04 -> | 3,2 | 6 | 160 | M4 | ZKG0437 | 005 |
| Kalos 1.2 | B12S1 | 03.05 -> | 1,2 | 4 | 53 | M4 | ZKG1111 | 011 |
| Matiz 1.0 | B10S1 | 03.05 -> | 1,0 | 4 | 49 | M4 | ZKG1111 | 011 |
| Matiz 1.0 | B10S | 03.05 -> | 1,0 | 4 | 47 | M4 | ZKG1111 | 011 |
| Rezzo 1.6 | A16DMS | 03.05 -> | 1,6 | 4 | 77 | M4 | ZKG1107 | 010 |
| Rezzo 1.6 | A16DMS | 08.05 -> | 1,6 | 4 | 79 | M4 | ZKG1107 | 010 |

Citroën

| | | | | | | | | |
|------------------------|--------------------------|---------------|-----|---|-----|----|---------|-----|
| C3 1.1i | HFX (TU1JP) | 02.02 -> | 1,1 | 4 | 44 | M4 | ZKG1555 | 020 |
| C3 1.4i Bivalent | KFV (TU3JP) | 02.02 -> | 1,4 | 4 | 54 | M4 | ZKG1555 | 020 |
| C3 1.6 16V | NFU (TU5JP4) | 02.02 -> | 1,6 | 4 | 80 | M4 | ZKG1555 | 020 |
| C3 1.6 Pluriel | NFU (TU5JP4) | 05.03 -> | 1,6 | 4 | 80 | M4 | ZKG1555 | 020 |
| Evasion 1.8 | LFZ (XU7JP) | 05.97 - 07.02 | 1,8 | 4 | 73 | M4 | ZKG1549 | 018 |
| Evasion 2.0 | RFU (XU10J2/C) | 06.94 - 07.02 | 2,0 | 4 | 89 | M4 | ZKG1550 | 019 |
| Evasion 2.0 Turbo C.T. | RGX (XU10J2TE) | 06.94 - 07.02 | 2,0 | 4 | 108 | M4 | ZKG1550 | 019 |
| Jumper 2.0 Bus | RFW (XU10J2U) | 02.94 - 04.02 | 2,0 | 4 | 80 | M4 | ZKG1549 | 018 |
| Jumper 2.0 Kasten | XU10J2U | 04.02 -> | 2,0 | 4 | 81 | M4 | ZKG1549 | 018 |
| Saxo 1.0 X | CDZ (TU9M) | 05.98 - 06.03 | 1,0 | 4 | 37 | M4 | ZKG1555 | 020 |
| Saxo 1.1 X, SX | HDZ (TU1M), HFX (TU1JP) | 05.96 - 09.03 | 1,1 | 4 | 44 | M4 | ZKG1555 | 020 |
| Saxo 1.1 X, SX | HDZ (TU1M) | 05.96 - 09.03 | 1,1 | 4 | 40 | M4 | ZKG1555 | 020 |
| Saxo 1.4 VTS | KFW (TU3JP), KFX (TU3JP) | 05.96 - 06.03 | 1,6 | 4 | 55 | M4 | ZKG1555 | 020 |
| Saxo 1.6 VTL, VTR | NFZ (TU5JP) | 05.96 - 06.03 | 1,6 | 4 | 65 | M4 | ZKG1555 | 020 |
| Xantia 1.6i | BFZ (XU5JP) | 03.93 - 01.98 | 1,6 | 4 | 65 | M4 | ZKG1549 | 018 |
| Xantia 1.8i | LFX (XU7JB) | 04.97 - 01.98 | 1,8 | 4 | 66 | M4 | ZKG1549 | 018 |
| Xantia 1.8i | LFZ (XU7JP) | 03.93 - 01.98 | 1,8 | 4 | 74 | M4 | ZKG1549 | 018 |
| Xantia 1.8i | LFX (XU7JB) | 01.98 - 04.03 | 1,8 | 4 | 66 | M4 | ZKG1549 | 018 |
| Xantia 1.8i 16V | LFY (XU7JP4) | 06.95 - 01.98 | 1,8 | 4 | 81 | M4 | ZKG1549 | 018 |
| Xantia 1.8i 16V | LFY (XU7JP4) | 01.98 - 04.03 | 1,8 | 4 | 81 | M4 | ZKG1549 | 018 |
| Xantia 1.8i 16V Break | LFY (XU7JP4) | 01.98 - 04.03 | 1,8 | 4 | 81 | M4 | ZKG1549 | 018 |
| Xantia 1.8i Break | LFZ (XU7JP) | 06.95 - 01.98 | 1,8 | 4 | 74 | M4 | ZKG1549 | 018 |
| Xantia 1.8i Break | LFX (XU7JB) | 01.98 - 04.03 | 1,8 | 4 | 66 | M4 | ZKG1549 | 018 |
| Xantia 2.0 Turbo | RGX (XU10J2TE) | 06.95 - 01.98 | 2,0 | 4 | 108 | M4 | ZKG1550 | 019 |
| Xantia 2.0i | RFX (XU10J2C) | 03.93 - 01.98 | 2,0 | 4 | 89 | M4 | ZKG1550 | 019 |
| Xantia 2.0i 16V | RFY (XU10J4/Z) | 03.93 - 01.98 | 2,0 | 4 | 112 | M4 | ZKG1550 | 019 |

| Typ Type | Motornummer Engine-No. | Baujahr Year | Liter Litre | Zyl. Cyl. | KW | Vert. Distr. | BBT-Nr. BBT-No. | Abb. Pict. |
|-------------------------|----------------------------|-----------------|----------------|--------------|-----|-----------------|--------------------|---------------|
| Xantia 2.0i 16V | RFV (XU10J4R) | 01.98 - 04.03 | 2,0 | 4 | 97 | M4 | ZKG1550 | 019 |
| Xantia 2.0i 16V Break | RFV (XU10J4R) | 01.98 - 04.03 | 2,0 | 4 | 97 | M4 | ZKG1550 | 019 |
| Xantia 2.0i Break | RFX (XU10J2) | 06.95 - 01.98 | 2,0 | 4 | 89 | M4 | ZKG1550 | 019 |
| Xantia 2.0i Turbo Break | RGX (XU10J2TE) | 01.98 - 04.03 | 2,0 | 4 | 108 | M4 | ZKG1550 | 019 |
| XM 2.0 Turbo | RGX (XU10J2TE) | 05.94 - 10.00 | 2,0 | 4 | 108 | M4 | ZKG1550 | 019 |
| XM 2.0i 16V | RFV (XU10J4R) | 05.94 - 10.00 | 2,0 | 4 | 97 | M4 | ZKG1550 | 019 |
| XM 2.0i Turbo | RGY (XU10J2TE/Z) | 09.92 - 06.94 | 2,0 | 4 | 104 | M4 | ZKG1550 | 019 |
| Xsara 1.4i | KFW (TU3JP), KFX (TU3JP) | 04.97 - 03.05 | 1,4 | 4 | 55 | M4 | ZKG1555 | 020 |
| Xsara 1.6i | NFZ (TU5JP) | 04.97 - 09.00 | 1,6 | 4 | 65 | M4 | ZKG1555 | 020 |
| Xsara 1.8i | LFX (XU7JB) | 04.97 - 09.00 | 1,8 | 4 | 66 | M4 | ZKG1549 | 018 |
| Xsara 1.8i 16V | LFY (XU7JP4) | 02.98 - 09.00 | 1,8 | 4 | 81 | M4 | ZKG1549 | 018 |
| Xsara 2.0 16V | RFS (XU10JSRS) | 04.97 - 09.00 | 2,0 | 4 | 120 | M4 | ZKG1550 | 019 |
| Xsara 2.0i 16V Coupe | RFS (XU10JSRS) | 02.98 - 03.05 | 2,0 | 4 | 120 | M4 | ZKG1550 | 019 |
| ZX 1.4i | KDX (TU3M/Z), KDZ (TU3M/Z) | 03.93 - 06.97 | 1,4 | 4 | 55 | M4 | ZKG1555 | 020 |
| ZX 1.6i | BDY (XU5M), BFZ (XU5JP) | 03.91 - 06.97 | 1,6 | 4 | 65 | M4 | ZKG1549 | 018 |
| ZX 1.8i | LFZ (XU7JP) | 07.92 - 06.97 | 1,8 | 4 | 74 | M4 | ZKG1549 | 018 |
| ZX 1.8i 16V | LFY (XU7JP4) | 01.96 - 06.97 | 1,8 | 4 | 81 | M4 | ZKG1549 | 018 |
| ZX 1.9i | DKZ (XU9JA) | 03.91 - 06.97 | 1,9 | 4 | 88 | M4 | ZKG1549 | 018 |
| ZX 2.0i | RFX (XU10J2C) | 07.92 - 06.97 | 2,0 | 4 | 89 | M4 | ZKG1550 | 019 |
| ZX 2.0i 16V | RFT (XU10J4/Z) | 06.94 - 06-97 | 2,0 | 4 | 110 | M4 | ZKG1550 | 019 |

Dacia

| | | | | | | | | |
|---------------|---------|----------|-----|---|----|----|----------|-----|
| Logan 1.4 | KJ7 710 | 09.04 -> | 1,4 | 4 | 55 | M4 | ZKG15112 | 022 |
| Logan 1.6 | K7M 710 | 09.04 -> | 1,6 | 4 | 64 | M4 | ZKG15112 | 022 |
| Logan MCV 1.4 | KJ7 710 | 02.07 -> | 1,4 | 4 | 55 | M4 | ZKG15112 | 022 |
| Logan MCV 1.6 | K7M 710 | 02.07 -> | 1,6 | 4 | 64 | M4 | ZKG15112 | 022 |
| Sandero 1.4 | KJ7 710 | 06.08 -> | 1,4 | 4 | 55 | M4 | ZKG15112 | 022 |
| Sandero 1.6 | K7M 710 | 06.08 -> | 1,6 | 4 | 64 | M4 | ZKG15112 | 022 |
| Solenza 1.4 | --- | 02.03 -> | 1,4 | 4 | 55 | M4 | ZKG1586 | 022 |

Daewoo

| | | | | | | | | |
|-----------|--------|----------|-----|---|----|----|---------|-----|
| Kalos 1.2 | --- | 04.03 -> | 1,2 | 4 | 53 | M4 | ZKG1111 | 011 |
| Matiz 1.0 | --- | 01.03 -> | 1,0 | 4 | 47 | M4 | ZKG1111 | 011 |
| Rezzo 1.6 | A16DMS | 09.00 -> | 1,6 | 4 | 77 | M4 | ZKG1107 | 010 |

Fiat

| | | | | | | | | |
|--------------------------------|-----------|---------------|-----|---|----|-----|---------|-----|
| 500 1.2 | 169 A4000 | 10.07 -> | 1,2 | 4 | 51 | M4 | ZKG1326 | 016 |
| 500 C 1.2 | 169 A4000 | 09.09 -> | 1,2 | 4 | 57 | M4 | ZKG1326 | 016 |
| Brava 1.6 16V | 182 A4000 | 02.96 - 10.01 | 1,6 | 4 | 76 | M4 | ZKG1392 | 017 |
| Brava 1.6 16V | 182 A6000 | 10.95 - 10.01 | 1,6 | 4 | 66 | M4 | ZKG1392 | 017 |
| Bravo 1.6 16V | 182 A4000 | 03.96 - 10.01 | 1,6 | 4 | 76 | M4 | ZKG1392 | 017 |
| Bravo 1.6 16V | 182 A6000 | 10.95 - 10.01 | 1,6 | 4 | 66 | M4 | ZKG1392 | 017 |
| Cinquecento 1.1 Sporting | 176 B2000 | 10.94 - 01.98 | 1,1 | 4 | 40 | DIN | ZKG1322 | 015 |
| Doblo 1.2 | 223 A5000 | 03.01 -> | 1,2 | 4 | 48 | DIN | ZKG1307 | 014 |
| Doblo 1.4 | 350 A1000 | 10.05 -> | 1,4 | 4 | 57 | M4 | ZKG1326 | 016 |
| Doblo 1.6 Natural Power | 182 B6000 | 09.02 -> | 1,6 | 4 | 76 | M4 | ZKG1392 | 017 |
| Doblo Cargo 1.2 | 223 A5000 | 03.01 -> | 1,2 | 4 | 48 | DIN | ZKG1307 | 014 |
| Doblo Cargo 1.4 | 350 A1000 | 10.05 -> | 1,4 | 4 | 57 | M4 | ZKG1326 | 016 |
| Doblo Cargo 1.6 Natural Power | 182 B6000 | 09.02 -> | 1,6 | 4 | 76 | M4 | ZKG1392 | 017 |
| Ducato 2.0 | RFL | 04.02 -> | 2,0 | 4 | 81 | M4 | ZKG1549 | 018 |
| Ducato 2.0 | RFW | 06.98 - 04.02 | 2,0 | 4 | 80 | M4 | ZKG1549 | 018 |
| Ducato 2.0 Combinato, Panorama | RFW | 03.94 - 04.02 | 2,0 | 4 | 80 | M4 | ZKG1549 | 018 |
| Grande Punto 1.2 | 199 A4000 | 10.05 -> | 1,2 | 4 | 48 | M4 | ZKG1326 | 016 |
| Grande Punto 1.4 | 350 A1000 | 10.05 -> | 1,4 | 4 | 57 | M4 | ZKG1326 | 016 |

| Typ Type | Motornummer Engine-No. | Baujahr Year | Liter Litre | Zyl. Cyl. | KW | Vert. Distr. | BBT-Nr. BBT-No. | Abb. Pict. |
|---------------------------|---------------------------|-----------------|----------------|--------------|-----|-----------------|--------------------|---------------|
| Idea 1.4 | 350 A1000 | 10.05 -> | 1,4 | 4 | 57 | M4 | ZKG1326 | 016 |
| Linea 1.4 | 350 A1000 | 06.07 -> | 1,4 | 4 | 57 | M4 | ZKG1326 | 016 |
| Marea 1.6 100 16V | 182 A4000 | 09.96 -> | 1,6 | 4 | 76 | M4 | ZKG1392 | 017 |
| Marea 1.6 100 16V Bipower | 185 A3000, 186 A4000 | 04.99 -> | 1,6 | 4 | 76 | M4 | ZKG1392 | 017 |
| Marea Weekend 1.6 100 16V | 182 A4000 | 09.96 -> | 1,6 | 4 | 76 | M4 | ZKG1392 | 017 |
| Multipla 1.6 100 16V | 182 A4000 | 04.99 -> | 1,6 | 4 | 76 | M4 | ZKG1392 | 017 |
| Multipla 1.6 16V Bipower | 182 B6000 | 10.01 -> | 1,6 | 4 | 76 | M4 | ZKG1392 | 017 |
| Multipla 1.6 16V Bipower | 186 A4000 | 04.99 -> | 1,6 | 4 | 76 | M4 | ZKG1392 | 017 |
| Multipla 1.6 16V Blupower | 182 B6000 | 04.02 -> | 1,6 | 4 | 70 | M4 | ZKG1392 | 017 |
| Multipla 1.6 16V Blupower | 186 A3000 | 04.99 -> | 1,6 | 4 | 70 | M4 | ZKG1392 | 017 |
| Palio Weekend 1.6 16V | 178 B3000 | 04.96 - 02.01 | 1,6 | 4 | 74 | M4 | ZKG1392 | 017 |
| Palio Weekend 1.6 16V | 182 B6000 | 02.01 -> | 1,6 | 4 | 76 | M4 | ZKG1392 | 017 |
| Panda 1.1 | 187 A1000 | 09.03 -> | 1,1 | 4 | 40 | DIN | ZKG1322 | 015 |
| Panda 1.2 | 188 A4000 | 09.03 -> | 1,2 | 4 | 44 | DIN | ZKG1322 | 015 |
| Panda 1.2 4x4 | 188 A4000 | 10.04 -> | 1,2 | 4 | 44 | DIN | ZKG1322 | 015 |
| Panda 1.2 Bi-Power | 188 A4000 | 01.07 -> | 1,2 | 4 | 44 | DIN | ZKG1307 | 014 |
| Punto 1.1 Van | 176 B2000 | 04.96 - 02.00 | 1,1 | 4 | 40 | DIN | ZKG1322 | 015 |
| Punto 1.2 Natural Power | 188 A4000 | 09.03 -> | 1,2 | 4 | 44 | DIN | ZKG1322 | 015 |
| Punto 55 1.1 | 176 A6000, 176 B2000 | 09.93 - 09.99 | 1,1 | 4 | 40 | DIN | ZKG1322 | 015 |
| Punto 60 1.2 | 176 A7000 | 01.94 - 09.99 | 1,2 | 4 | 43 | DIN | ZKG1322 | 015 |
| Punto 60 1.2 | 176 B1000, 176 B4000 | 03.94 - 09.99 | 1,2 | 4 | 44 | DIN | ZKG1322 | 015 |
| Punto 60 1.2 | 188 A4000 | 09.99 -> | 1,2 | 4 | 44 | DIN | ZKG1322 | 015 |
| Punto 60 1.2 Cabriolet | 176 A7000 | 04.94 - 06.00 | 1,2 | 4 | 43 | DIN | ZKG1322 | 015 |
| Punto 60 1.2 Cabriolet | 176 B1000, 176 B4000 | 05.95 - 06.00 | 1,2 | 4 | 44 | DIN | ZKG1322 | 015 |
| Punto 60 1.2 Van | 188 A4000 | 02.00 -> | 1,2 | 4 | 44 | DIN | ZKG1322 | 015 |
| Punto 75 1.2 | 176 A8000 | 10.93 - 09.99 | 1,2 | 4 | 54 | DIN | ZKG1322 | 015 |
| Punto Evo 1.2 | 199 A4000 | 10.09 -> | 1,2 | 4 | 48 | M4 | ZKG1326 | 016 |
| Punto Evo 1.4 | 350 A1000 | 10.09 -> | 1,4 | 4 | 77 | M4 | ZKG1326 | 016 |
| Seicento 1.1 | 176 B2000, 187 A1000 | 01.98 -> | 1,1 | 4 | 40 | DIN | ZKG1322 | 015 |
| Strada 1.2 | 178 B5000 | 06.99 -> | 1,2 | 4 | 54 | DIN | ZKG1322 | 015 |
| Ulysee 2.0 Turbo | RGX (XU10J2CTE) | 06.94 - 08.02 | 2,0 | 4 | 108 | M4 | ZKG1550 | 019 |
| Ulysse 1.8 | LFW | 05.97 - 08.02 | 1,8 | 4 | 73 | M4 | ZKG1550 | 019 |
| Ulysse 2.0 | RFU (XU10J2C) | 06.94 - 08.02 | 2,0 | 4 | 89 | M4 | ZKG1550 | 019 |

Ford

| | | | | | | | | |
|-------------------|------------------------------|---------------|-----|---|-----|----|---------|-----|
| C-Max 1.6 | SHDA, SHDB | 02.07 -> | 1,6 | 4 | 74 | M4 | ZKG1899 | 023 |
| Cougar 2.0 16V | EDBA, EDBB, EDBC, EDBD | 08.98 - 12.01 | 2,0 | 4 | 96 | M4 | ZKG1890 | 023 |
| Fiesta V 1.25 16V | FUJA, FUJB | 05.02 -> | 1,3 | 4 | 55 | M4 | ZKG1899 | 023 |
| Fiesta V 1.25 16V | M7JA, M7JB | 03.03 -> | 1,3 | 4 | 51 | M4 | ZKG1899 | 023 |
| Fiesta V 1.3 | A9JA, A9JB | 11.01 -> | 1,3 | 4 | 51 | M4 | ZKG1898 | 024 |
| Fiesta V 1.3 | BAJA | 11.01 -> | 1,3 | 4 | 44 | M4 | ZKG1898 | 024 |
| Fiesta V 1.4 16V | FXJA, FXJB | 11.01 -> | 1,4 | 4 | 59 | M4 | ZKG1899 | 023 |
| Fiesta V 1.6 16V | FYJA | 11.01 -> | 1,6 | 4 | 74 | M4 | ZKG1899 | 023 |
| Fiesta Van 1.25 | SNJA, SNJB | 01.09 -> | 1,2 | 4 | 60 | M4 | ZKG1899 | 023 |
| Fiesta VI 1.25 | SNJA, SNJB | 10.08 -> | 1,2 | 4 | 60 | M4 | ZKG1899 | 023 |
| Fiesta Vi 1.25 | STJA, STJB | 10.08 -> | 1,2 | 4 | 44 | M4 | ZKG1899 | 023 |
| Fiesta VI 1.4 | SPJA, SPJC | 10.08 -> | 1,4 | 4 | 71 | M4 | ZKG1899 | 023 |
| Fiesta VI 1.4 LPG | RTJA, RTJB | 01.09 -> | 1,4 | 4 | 71 | M4 | ZKG1899 | 023 |
| Fiesta VI 1.6 Ti | --- | 10.08 -> | 1,6 | 4 | 88 | M4 | ZKG1899 | 023 |
| Focus 1.8 16V | EYDB, EYDC, EYDD, EYDE, EYDF | 10.98 - 11.04 | 1,8 | 4 | 85 | M4 | ZKG1890 | 023 |
| Focus 2.0 16V | EDDB, EDDC, EDDD, EDDF | 10.98 - 11.04 | 2,0 | 4 | 96 | M4 | ZKG1890 | 023 |
| Focus 2.0 RS | HMDA | 10.02 - 11.04 | 2,0 | 4 | 158 | M4 | ZKG1890 | 023 |
| Focus 2.0 ST170 | ALDA | 03.02 - 11.04 | 2,0 | 4 | 127 | M4 | ZKG1890 | 023 |
| Focus C-Max 1.6 | HWDA, HWDB | 10.03 - 03.07 | 1,6 | 4 | 74 | M4 | ZKG1890 | 023 |

| Type | Motornummer Engine-No. | Baujahr Year | Liter Litre | Zyl. Cyl. | KW | Vert. Distr. | BBT-Nr. BBT-No. | Abb. Pict. |
|------------------------|-----------------------------------|-----------------|----------------|--------------|----|-----------------|--------------------|---------------|
| Focus C-Max 1.6 | HXJA, HXJB | 10.03 - 03.07 | 1,6 | 4 | 74 | M4 | ZKG1899 | 023 |
| Focus C-Max 1.6 Ti | HXDA, SIDA | 08.04 - 03.07 | 1,6 | 4 | 85 | M4 | ZKG1899 | 023 |
| Focus II 1.4 | ASDA, ASDB | 11.04 -> | 1,4 | 4 | 59 | M4 | ZKG1890 | 023 |
| Focus II 1.4 | ASDA, ASDB | 04.05 -> | 1,4 | 4 | 59 | M4 | ZKG1890 | 023 |
| Focus II 1.6 | HWDA, HWDB, SHDA | 11.04 -> | 1,6 | 4 | 74 | M4 | ZKG1890 | 023 |
| Focus II 1.6 | HWDA, HWDB, SHDA | 04.05 -> | 1,6 | 4 | 74 | M4 | ZKG1890 | 023 |
| Focus II 1.6 LPG | SIDA | 10.09 -> | 1,6 | 4 | 85 | M4 | ZKG1899 | 023 |
| Focus II 1.6 Ti | HWDA, HWDB | 04.05 -> | 1,6 | 4 | 85 | M4 | ZKG1890 | 023 |
| Focus II 1.6 Ti | HXDA, HXDB | 11.04 -> | 1,6 | 4 | 85 | M4 | ZKG1890 | 023 |
| Focus II Cabriolet 1.6 | HWDA, HWDB | 10.06 -> | 1,6 | 4 | 74 | M4 | ZKG1890 | 023 |
| Fusion 1.25 | FUJA, FUJB | 08.04 -> | 1,3 | 4 | 55 | M4 | ZKG1899 | 023 |
| Fusion 1.4 | FXJA, FXJB | 08.02 -> | 1,4 | 4 | 59 | M4 | ZKG1899 | 023 |
| Fusion 1.6 | FYJA | 08.02 -> | 1,6 | 4 | 74 | M4 | ZKG1899 | 023 |
| KA 1.3i | A9A, A9B | 08.02 -> | 1,3 | 4 | 51 | M4 | ZKG1898 | 024 |
| KA 1.3i | BAA, J4D, J4K, J4M, J4N, J4P, J4S | 09.96 -> | 1,3 | 4 | 44 | M4 | ZKG1898 | 024 |
| KA 1.6i | CDB, CDC | 07.03 -> | 1,6 | 4 | 70 | M4 | ZKG1898 | 024 |
| Maverick 2.0 16V | YF | 02.01 -> | 2,0 | 4 | 91 | M4 | ZKG1890 | 023 |
| Mondeo IV 1.6 Ti | --- | 03.07 -> | 1,6 | 4 | 81 | M4 | ZKG1899 | 023 |
| Mondeo IV 1.6 Ti | PNBA | 07.10 -> | 1,6 | 4 | 88 | M4 | ZKG1899 | 023 |
| Mondeo IV 1.6 Ti | RHBA | 03.07 -> | 1,6 | 4 | 92 | M4 | ZKG1899 | 023 |
| Street KA 1.6 | CDRA, CDRB | 05.03 - 07.05 | 1,6 | 4 | 70 | M4 | ZKG1898 | 024 |

Mazda

| | | | | | | | | |
|--------|------|----------|-----|---|-----|----|---------|-----|
| 2 1.25 | FUJA | 04.03 -> | 1,3 | 4 | 55 | M4 | ZKG1899 | 023 |
| 2 1.4 | FXJA | 04.03 -> | 1,4 | 4 | 59 | M4 | ZKG1899 | 023 |
| 2 1.6 | FYJA | 04.03 -> | 1,6 | 4 | 74 | M4 | ZKG1899 | 023 |
| 6 1.8 | L813 | 08.02 -> | 1,8 | 4 | 88 | M4 | ZKG1729 | 023 |
| 6 2.0 | LF17 | 08.02 -> | 2,0 | 4 | 104 | M4 | ZKG1729 | 023 |

MCC (Micro Compact Car)

| | | | | | | | | |
|-------------------------------|---------------|---------------|-----|---|----|----|---------|-----|
| Smart Cabrio 0.6 | --- | 06.02 - 01.04 | 0,6 | 3 | 52 | M4 | ZKG0441 | 026 |
| Smart Cabrio 0.6 | M160 E6AL B03 | 03.00 - 01.04 | 0,6 | 3 | 40 | M4 | ZKG0441 | 026 |
| Smart Cabrio 0.6 | M160 E6AL B05 | 01.01 - 01.04 | 0,6 | 3 | 45 | M4 | ZKG0441 | 026 |
| Smart Cabrio 0.7 | --- | 01.03 - 01.04 | 0,7 | 3 | 45 | M4 | ZKG0441 | 026 |
| Smart City-Coupe 0.6 | M160 E6AL B04 | 07.98 - 01.04 | 0,6 | 3 | 33 | M4 | ZKG0441 | 026 |
| Smart City-Coupe 0.7 | --- | 01.03 - 01.04 | 0,7 | 3 | 37 | M4 | ZKG0441 | 026 |
| Smart Fortwo Coupe 1.0 | M132.910 | 01.07 -> | 1,0 | 3 | 45 | M4 | ZKG0441 | 026 |
| Smart Fortwo Coupe 1.0 Brabus | M132.930 | 01.08 -> | 1,0 | 3 | 72 | M4 | ZKG0441 | 026 |
| Smart Fortwo Coupe 1.0 Turbo | M132.930 | 01.07 -> | 1,0 | 3 | 62 | M4 | ZKG0441 | 026 |

Mercedes Benz

| | | | | | | | | |
|------------------|--------------------|---------------|-----|---|-----|-----|---------|-----|
| 190 2.0 (W201) | M102.921 | 10.82 - 10.84 | 2,0 | 4 | 66 | SAE | ZKG0415 | 004 |
| 190 2.0 (W201) | M102.924 | 01.86 - 05.90 | 2,0 | 4 | 75 | SAE | ZKG0415 | 004 |
| 190 2.0 (W201) | M102.924 | 09.84 - 05.90 | 2,0 | 4 | 77 | SAE | ZKG0415 | 004 |
| 190 E 1.8 (W201) | M102.910 | 04.90 - 08.93 | 1,8 | 4 | 80 | SAE | ZKG0415 | 004 |
| 190 E 2.0 (W201) | M102.961, M102.962 | 02.85 - 12.86 | 2,0 | 4 | 83 | SAE | ZKG0415 | 004 |
| 190 E 2.0 (W201) | M102.961, M102.962 | 10.82 - 06.93 | 2,0 | 4 | 90 | SAE | ZKG0415 | 004 |
| 190 E 2.3 (W201) | M102.985 | 09.86 - 08.91 | 2,3 | 4 | 97 | SAE | ZKG0415 | 004 |
| 190 E 2.3 (W201) | M102.985 | 10.86 - 08.93 | 2,3 | 4 | 100 | SAE | ZKG0415 | 004 |
| 200 (W123) | M102.939 | 06.80 - 11.85 | 2,0 | 4 | 74 | SAE | ZKG0415 | 004 |
| 200 (W123) | M102.920 | 06.80 - 11.85 | 2,0 | 4 | 80 | SAE | ZKG0415 | 004 |
| 200 (W124) | M102.922 | 01.86 - 05.90 | 2,0 | 4 | 77 | SAE | ZKG0415 | 004 |
| 200 (W124) | M102.922 | 12.85 - 05.90 | 2,0 | 4 | 75 | SAE | ZKG0415 | 004 |
| 200 E (W124) | M102.963 | 09.88 - 08.92 | 2,0 | 4 | 87 | SAE | ZKG0415 | 004 |

| Typ Type | Motornummer Engine-No. | Baujahr Year | Liter Litre | Zyl. Cyl. | KW | Vert. Distr. | BBT-Nr. BBT-No. | Abb. Pict. |
|----------------------------|---------------------------|-----------------|----------------|--------------|-----|-----------------|--------------------|---------------|
| 200 E (W124) | M111.960 | 10.92 - 06.93 | 2,0 | 4 | 110 | SAE | ZKG0415 | 004 |
| 200 E (W124) | M102.982 | 01.85 - 06.93 | 2,0 | 4 | 100 | SAE | ZKG0415 | 004 |
| 200 T (S123) | M102.920 | 11.80 - 11.85 | 2,0 | 4 | 80 | SAE | ZKG0415 | 004 |
| 200 T (S124) | M102.922 | 01.86 - 05.90 | 2,0 | 4 | 77 | SAE | ZKG0415 | 004 |
| 220 CE (C124) | M111.960 | 10.92 - 05.93 | 2,2 | 4 | 110 | SAE | ZKG0415 | 004 |
| 230 CE (C123) | M102.980 | 04.80 - 12.85 | 2,3 | 4 | 100 | SAE | ZKG0415 | 004 |
| 230 CE (C124) | M102.982 | 03.87 - 12.92 | 2,3 | 4 | 100 | SAE | ZKG0415 | 004 |
| 230 CE (C124) Kat. | M102.982 | 06.89 - 12.92 | 2,3 | 4 | 97 | SAE | ZKG0415 | 004 |
| 230 E (W123) | M102.980 | 04.80 - 12.85 | 2,3 | 4 | 100 | SAE | ZKG0415 | 004 |
| 230 E (W124) | M102.982 | 12.84 - 03.92 | 2,3 | 4 | 97 | SAE | ZKG0415 | 004 |
| 230 E (W124) Kat. | M102.982 | 06.89 - 06.93 | 2,3 | 4 | 97 | SAE | ZKG0415 | 004 |
| 230 GE (W460) | M102.979, M102.987 | 05.87 - 08.92 | 2,3 | 4 | 92 | SAE | ZKG0415 | 004 |
| 230 GE (W460) | M102.981, M102.987 | 04.82 - 08.92 | 2,3 | 4 | 92 | SAE | ZKG0415 | 004 |
| 230 GE (W461) | M102.996, M102.997 | 06.93 -> | 2,3 | 4 | 92 | SAE | ZKG0415 | 004 |
| 230 GE (W461) | M102.979 | 02.93 -> | 2,3 | 4 | 90 | SAE | ZKG0415 | 004 |
| 230 GE (W463) | M102.989 | 06.90 - 06.93 | 2,3 | 4 | 93 | SAE | ZKG0415 | 004 |
| 230 TE (S123) | M102.980 | 04.80 - 11.85 | 2,3 | 4 | 100 | SAE | ZKG0415 | 004 |
| 230 TE (S124) Kat. | M102.982 | 06.89 - 08.92 | 2,3 | 4 | 97 | SAE | ZKG0415 | 004 |
| A 150 (W169) | M266.920 | 09.04 -> | 1,5 | 4 | 70 | M4 | ZKG0452 | 005 |
| A 160 (W169) | M266.920 | 04.09 -> | 1,5 | 4 | 70 | M4 | ZKG0452 | 005 |
| A 170 (W169) | M266.940 | 09.04 -> | 1,7 | 4 | 85 | M4 | ZKG0452 | 005 |
| A 180 (W169) | M266.940 | 04.09 -> | 1,7 | 4 | 85 | M4 | ZKG0452 | 005 |
| A 200 (W169) | M266.960 | 09.04 -> | 2,0 | 4 | 100 | M4 | ZKG0452 | 005 |
| A 200 (W169) | M266.980 | 09.05 -> | 2,0 | 4 | 142 | M4 | ZKG0452 | 005 |
| B 150 (W245) | M266.920 | 03.05 -> | 1,5 | 4 | 70 | M4 | ZKG0452 | 005 |
| B 160 (W245) | M266.920 | 04.09 -> | 1,5 | 4 | 70 | M4 | ZKG0452 | 005 |
| B 170 (W245) | M266.940 | 03.05 -> | 1,7 | 4 | 85 | M4 | ZKG0452 | 005 |
| B 180 (W245) | M266.940 | 04.09 -> | 1,7 | 4 | 85 | M4 | ZKG0452 | 005 |
| B 200 (W245) | M266.960 | 03.05 -> | 2,0 | 4 | 100 | M4 | ZKG0452 | 005 |
| B 200 Turbo (W245) | M266.980 | 03.05 -> | 2,0 | 4 | 142 | M4 | ZKG0452 | 005 |
| C 240 (W202) | M112.910 | 06.97 - 05.00 | 2,4 | 6 | 125 | M4 | ZKG0437 | 005 |
| C 240 (W203) | M112.912 | 05.00 -> | 2,4 | 6 | 125 | M4 | ZKG0437 | 005 |
| C 240 4-matic (W203) | M112.916 | 07.02 -> | 2,4 | 6 | 125 | M4 | ZKG0437 | 005 |
| C 240 T (S202) | M112.910 | 06.97 - 05.00 | 2,4 | 6 | 125 | M4 | ZKG0437 | 005 |
| C 280 (W202) | M112.920 | 06.97 - 05.00 | 2,8 | 6 | 145 | M4 | ZKG0437 | 005 |
| C 280 T (S202) | M112.920 | 06.97 - 03.01 | 2,8 | 6 | 145 | M4 | ZKG0437 | 005 |
| C 32 AMG Kompressor (W203) | M112.961 | 02.01 -> | 3,2 | 6 | 260 | M4 | ZKG0437 | 005 |
| C 320 (W203) | M112.946 | 05.00 -> | 3,2 | 6 | 160 | M4 | ZKG0437 | 005 |
| C 320 4-matic (W203) | M112.953 | 07.02 -> | 3,2 | 6 | 160 | M4 | ZKG0437 | 005 |
| C 320 Sportcoupe (CL203) | M112.946 | 09.02 -> | 3,2 | 6 | 160 | M4 | ZKG0437 | 005 |
| CL 500 (C215) | M113.960 | 03.99 - 03.06 | 5,0 | 8 | 225 | M4 | ZKG0440 | 005 |
| CLK 240 (C209) | M112.912 | 06.02 -> | 2,4 | 6 | 125 | M4 | ZKG0437 | 005 |
| CLK 320 (C208) | M112.940 | 06.97 - 06.02 | 3,2 | 6 | 160 | M4 | ZKG0437 | 005 |
| CLK 320 (C208) | M112.955 | 06.02 -> | 3,2 | 6 | 160 | M4 | ZKG0437 | 005 |
| CLK 430 (C208) | M113.943 | 07.98 - 06.02 | 4,3 | 8 | 205 | M4 | ZKG0440 | 005 |
| CLK 500 (C209) | M113.968 | 06.02 -> | 5,0 | 8 | 225 | M4 | ZKG0440 | 005 |
| CLK 55 AMG (C208) | M113.981, M113.984 | 08.99 - 06.02 | 5,5 | 8 | 255 | M4 | ZKG0440 | 005 |
| E 200 Kompressor (W210) | M111.947 | 06.97 - 03.02 | 2,0 | 4 | 137 | M4 | ZKG0444 | 006 |
| E 200 T Kompressor (S210) | M111.947 | 06.97 - 03.03 | 2,0 | 4 | 137 | M4 | ZKG0444 | 006 |
| E 230 (W210) | M111.970 | 06.95 - 06.97 | 2,3 | 4 | 110 | M4 | ZKG0444 | 006 |
| E 240 (W210) | M112.911 | 06.97 - 08.00 | 2,4 | 6 | 125 | M4 | ZKG0437 | 005 |
| E 240 (W210) | M112.914 | 08.00 - 03.02 | 2,4 | 6 | 125 | M4 | ZKG0437 | 005 |
| E 240 (W211) | M112.913, M112.917 | 03.02 -> | 2,4 | 6 | 130 | M4 | ZKG0437 | 005 |
| E 240 4-matic (W211) | M112.917 | 03.03 -> | 2,4 | 6 | 130 | M4 | ZKG0437 | 005 |

| Type | Motornummer | Baujahr | Liter | Zyl. | KW | Vert. | BBT-Nr. | Abb. |
|------------------------------|----------------------------|---------------|-------|------|-----|--------|---------|-------|
| Type | Engine-No. | Year | Litre | Cyl. | | Distr. | BBT-No. | Pict. |
| E 280 (W210) | M112.921 | 12.96 - 03.02 | 2,8 | 6 | 150 | M4 | ZKG0437 | 005 |
| E 280 4-matic (W210) | M112.921 | 12.96 - 03.02 | 2,8 | 6 | 150 | M4 | ZKG0437 | 005 |
| E 320 (W210) | M112.941 | 06.97 - 03.02 | 3,2 | 6 | 165 | M4 | ZKG0437 | 005 |
| E 320 (W211) | M112.949 | 03.02 -> | 3,2 | 6 | 165 | M4 | ZKG0437 | 005 |
| E 430 (W210) | M113.940 | 06.97 - 03.02 | 4,3 | 8 | 205 | M4 | ZKG0440 | 005 |
| E 500 (W211) | M113.967 | 03.02 -> | 5,0 | 8 | 225 | M4 | ZKG0440 | 005 |
| E 55 AMG Kompressor (W211) | M113.990 | 10.02 -> | 5,5 | 8 | 350 | M4 | ZKG0440 | 005 |
| G 500 (W463) | M113.962 | 04.98 -> | 5,0 | 8 | 218 | M4 | ZKG0440 | 005 |
| ML 230 (W163) | M111.977 | 02.98 - 06.05 | 2,3 | 4 | 110 | M4 | ZKG0444 | 006 |
| ML 430 (W163) | M113.942 | 02.98 - 06.05 | 4,3 | 8 | 200 | M4 | ZKG0440 | 005 |
| ML 500 (W163) | M113.964, M113.965 | 09.01 - 06.05 | 5,0 | 8 | 215 | M4 | ZKG0440 | 005 |
| ML 55 AMG (W163) | M113.981 | 02.00 - 06.05 | 5,5 | 8 | 255 | M4 | ZKG0440 | 005 |
| S 430 (W220) | M113.941 | 10.98 - 08.05 | 4,3 | 8 | 205 | M4 | ZKG0440 | 005 |
| S 500 (W220) | M113.960 | 10.98 - 08.05 | 5,0 | 8 | 225 | M4 | ZKG0440 | 005 |
| SL 280 (R129) | M112.923, M112.925 | 05.98 - 10.01 | 2,8 | 6 | 150 | M4 | ZKG0437 | 005 |
| SL 320 (R129) | M112.943 | 05.98 - 10.01 | 3,2 | 6 | 165 | M4 | ZKG0437 | 005 |
| SL 350 (R230) | M112.973 | 03.03 -> | 3,5 | 6 | 180 | M4 | ZKG0437 | 005 |
| SL 500 (R129) | M113.961 | 05.98 - 10.01 | 5,0 | 8 | 225 | M4 | ZKG0440 | 005 |
| SL 500 (R230) | M113.963 | 10.01 -> | 5,0 | 8 | 225 | M4 | ZKG0440 | 005 |
| SLK 200 Kompressor (R170) | M111.958 | 03.00 - 04.04 | 2,0 | 4 | 120 | M4 | ZKG0444 | 006 |
| SLK 32 AMG Kompressor (R170) | M112.960 | 03.01 - 04.04 | 3,2 | 6 | 260 | M4 | ZKG0437 | 005 |
| SLK 320 (R170) | M112.947 | 03.00 - 04.04 | 3,2 | 6 | 260 | M4 | ZKG0437 | 005 |
| Sprinter 2-t 214 NGT | M111.984 | 04.00 - 05.06 | 2,3 | 4 | 92 | M4 | ZKG0444 | 006 |
| Sprinter 3-t 314 NGT | M111.984 | 04.00 - 05.06 | 2,3 | 4 | 92 | M4 | ZKG0444 | 006 |
| Mini | | | | | | | | |
| Cooper 1.6 | W10B16A | 06.01 -> | 1,6 | 4 | 85 | SAE | ZKG1248 | 012 |
| Cooper S 1.6 | W11B16A | 07.04 -> | 1,6 | 4 | 125 | SAE | ZKG1248 | 012 |
| Cooper S 1.6 | W111B16A | 03.02 -> | 1,6 | 4 | 120 | SAE | ZKG1248 | 012 |
| One 1.6 | W10B16A | 06.01 -> | 1,6 | 4 | 66 | SAE | ZKG1248 | 012 |
| Peugeot | | | | | | | | |
| 106 I 1.0 | CDY (TU9M) | 09.91 - 04.96 | 1,0 | 4 | 33 | M4 | ZKG1555 | 020 |
| 106 I 1.1 | HDZ (TU1M) | 09.91 - 04.96 | 1,1 | 4 | 44 | M4 | ZKG1555 | 020 |
| 106 I 1.3 | TU2J2 | 10.93 - 04.96 | 1,3 | 4 | 72 | M4 | ZKG1555 | 020 |
| 106 I 1.4 | KFZ (TU3J2/Z) | 09.91 - 04.96 | 1,4 | 4 | 69 | M4 | ZKG1555 | 020 |
| 106 II 1.0i | CDZ (TU9M) | 01.97 -> | 1,0 | 4 | 37 | M4 | ZKG1555 | 020 |
| 106 II 1.1i | HDY (TU1M) | 01.97 -> | 1,1 | 4 | 40 | M4 | ZKG1555 | 020 |
| 106 II 1.1i | HDZ (TU1M), HFX (TU1JP) | 05.96 -> | 1,1 | 4 | 44 | M4 | ZKG1555 | 020 |
| 106 II 1.4i | KFW (TU3JP), KFX (TU3JP) | 05.96 -> | 1,4 | 4 | 55 | M4 | ZKG1555 | 020 |
| 106 II 1.6i | NFW (TU5J2) | 05.96 -> | 1,6 | 4 | 74 | M4 | ZKG1555 | 020 |
| 106 II 1.6i | NFZ (TU5JP) | 05.96 -> | 1,6 | 4 | 65 | M4 | ZKG1555 | 020 |
| 205 I 1.6 CJ Cabriolet | BDY (XU5M3Z) | 08.92 - 12.94 | 1,6 | 4 | 65 | M4 | ZKG1549 | 018 |
| 205 I 1.9 CTI Cabriolet | DFZ (XU9J1) | 10.87 - 12.94 | 1,9 | 4 | 75 | M4 | ZKG1549 | 018 |
| 205 II 1.6 Aut. | BDY (XU5M2Z), BDY (XU5M3Z) | 05.90 - 09.98 | 1,6 | 4 | 65 | M4 | ZKG1549 | 018 |
| 205 II 1.9 GTI Kat. | DFZ (XU9J1) | 10.87 - 12.94 | 1,9 | 4 | 75 | M4 | ZKG1549 | 018 |
| 306 1.1 | HDZ (TU1M) | 07.96 - 05.01 | 1,1 | 4 | 44 | M4 | ZKG1555 | 020 |
| 306 1.4 | KDX (TU3MC), KFW (TU3JP) | 05.93 - 05.01 | 1,4 | 4 | 55 | M4 | ZKG1555 | 020 |
| 306 1.4 SL | KDX (TU3MC), KFW (TU3JP) | 06.94 - 05.01 | 1,4 | 4 | 55 | M4 | ZKG1555 | 020 |
| 306 1.6 Break | NFZ (TU5JP) | 03.97 - 10.00 | 1,6 | 4 | 65 | M4 | ZKG1555 | 020 |
| 306 1.6 SR | NFZ (TU5JP) | 06.94 - 10.00 | 1,6 | 4 | 65 | M4 | ZKG1555 | 020 |
| 306 1.8 16V | LFY (XU7JP4) | 03.97 - 05.01 | 1,8 | 4 | 81 | M4 | ZKG1549 | 018 |
| 306 1.8 16V Break | LFY (XU7JP4) | 03.97 - 04.02 | 1,8 | 4 | 81 | M4 | ZKG1549 | 018 |
| 306 1.8 16V Cabriolet | LFY (XU7JP4) | 07.00 - 04.02 | 1,8 | 4 | 81 | M4 | ZKG1549 | 018 |

| Type | Motornummer Engine-No. | Baujahr Year | Liter Litre | Zyl. Cyl. | KW | Vert. Distr. | BBT-Nr. BBT-No. | Abb. Pict. |
|-----------------------------|----------------------------|-----------------|----------------|--------------|-----|-----------------|--------------------|---------------|
| 306 1.8 Break | LFZ (XU7JP) | 03.97 - 04.02 | 1,8 | 4 | 74 | M4 | ZKG1549 | 018 |
| 306 1.8 Cabriolet | LFZ (XU7JP) | 03.94 - 04.02 | 1,8 | 4 | 74 | M4 | ZKG1549 | 018 |
| 306 1.8 ST | LFZ (XU7JP) | 06.94 - 05.01 | 1,8 | 4 | 74 | M4 | ZKG1549 | 018 |
| 306 2.0 | RFV (XU10J4R) | 03.97 - 05.01 | 2,0 | 4 | 97 | M4 | ZKG1550 | 019 |
| 306 2.0 16V Cabriolet | RFV (XU10J4R) | 03.97 - 04.02 | 2,0 | 4 | 97 | M4 | ZKG1550 | 019 |
| 306 2.0 ST | RFX (XU10J2) | 07.94 - 05.01 | 2,0 | 4 | 89 | M4 | ZKG1550 | 019 |
| 309 II 1.4 | KDY (TU3M), KDX (TU3M) | 07.89 - 12.93 | 1,4 | 4 | 55 | M4 | ZKG1555 | 020 |
| 309 II 1.6 | BDY (XU5M2Z), BDY (XU5M3Z) | 07.89 - 12.93 | 1,6 | 4 | 65 | M4 | ZKG1549 | 018 |
| 405 II 1.6 (Ch. 70119981->) | BDY (XU5M2Z), BDY (XU5M3Z) | 08.92 - 10.95 | 1,6 | 4 | 65 | M4 | ZKG1549 | 018 |
| 405 II 1.8 | LFZ (XU7JP) | 08.92 - 10.95 | 1,8 | 4 | 74 | M4 | ZKG1549 | 018 |
| 405 II 1.8 Break | LFZ (XU7JP) | 08.92 - 10.96 | 1,8 | 4 | 74 | M4 | ZKG1549 | 018 |
| 405 II 2.0 | RFX (XU10J2) | 08.92 - 10.95 | 2,0 | 4 | 89 | M4 | ZKG1550 | 019 |
| 406 1.6 | BFZ (XU5JP) | 11.95 - 05.04 | 1,6 | 4 | 65 | M4 | ZKG1549 | 018 |
| 406 1.8 | LFX (XU7JB) | 05.97 - 05.04 | 1,8 | 4 | 66 | M4 | ZKG1549 | 018 |
| 406 1.8 16V | LFY (XU7JP4) | 11.95 - 10.00 | 1,8 | 4 | 81 | M4 | ZKG1549 | 018 |
| 406 2.0 16V | RFV (XU10J4R) | 11.95 - 05.04 | 2,0 | 4 | 97 | M4 | ZKG1550 | 019 |
| 406 2.0 16V Coupe | RFV (XU10J4R) | 03.97 - 12.04 | 2,0 | 4 | 97 | M4 | ZKG1550 | 019 |
| 406 2.0 Turbo | RGX (XU10J2TE) | 04.96 - 05.04 | 2,0 | 4 | 108 | M4 | ZKG1550 | 019 |
| 605 2.0 Turbo | RGX (XU10J2TE) | 07.92 - 09.99 | 2,0 | 4 | 104 | M4 | ZKG1550 | 019 |
| 605 2.0 Turbo | RGX (XU10J2TE) | 07.91 - 09.99 | 2,0 | 4 | 108 | M4 | ZKG1550 | 019 |
| 806 2.0 | RFU (XU10J2) | 06.94 - 08.02 | 2,0 | 4 | 89 | M4 | ZKG1550 | 019 |
| 806 2.0 16V | RFV (XU10J4R) | 05.98 - 09.00 | 2,0 | 4 | 97 | M4 | ZKG1550 | 019 |
| 806 2.0 Turbo | RGX (XU10J2TE) | 06.94 - 08.02 | 2,0 | 4 | 108 | M4 | ZKG1550 | 019 |
| Boxer 2.0i | RFW (XU10J2) | 03.94 - 04.02 | 2,0 | 4 | 80 | M4 | ZKG1549 | 018 |
| Partner 1.4 | KFX (TU3JP), TU32 | 06.96 -> | 1,4 | 4 | 55 | M4 | ZKG1555 | 020 |
| Partner Combispace 1.1 | HDZ (TU1M), HFX (TU1JP) | 06.96 -> | 1,1 | 4 | 44 | M4 | ZKG1555 | 020 |
| Partner Combispace 1.8 | LFX (XU7JB) | 05.97 -> | 1,8 | 4 | 66 | M4 | ZKG1549 | 018 |

Renault

| | | | | | | | | |
|--------------------------------|---------------------------|----------|-----|---|----|----|----------|-----|
| Clio Grandtour 1.2 16V | D4F 764 | 02.08 -> | 1,2 | 4 | 58 | M4 | ZKG1571 | 021 |
| Clio Grandtour 1.2 16V | D4F 740 | 02.08 -> | 1,2 | 4 | 55 | M4 | ZKG1571 | 021 |
| Clio Grandtour 1.2 16V | D4F 784 | 02.08 -> | 1,2 | 4 | 74 | M4 | ZKG1571 | 021 |
| Clio Grandtour 1.2 16V Hi-Flex | D4F 740 | 07.08 -> | 1,2 | 4 | 55 | M4 | ZKG1571 | 021 |
| Clio III 1.2 16V | D4F 764 | 06.05 -> | 1,2 | 4 | 58 | M4 | ZKG1571 | 021 |
| Clio III 1.2 16V | D4F 784 | 05.07 -> | 1,2 | 4 | 74 | M4 | ZKG1571 | 021 |
| Clio III 1.2 16V | D4F 740 | 06.05 -> | 1,2 | 4 | 55 | M4 | ZKG1571 | 021 |
| Clio III 1.2 16V | D4F 740 | 06.05 -> | 1,2 | 4 | 48 | M4 | ZKG1571 | 021 |
| Clio III 1.2 16V Hi-Flex | D4F 740 | 07.08 -> | 1,2 | 4 | 55 | M4 | ZKG1571 | 021 |
| Kangoo 1.2 16V | D4F 712, D4F 714, D4F 716 | 06.01 -> | 1,2 | 4 | 55 | M4 | ZKG1571 | 021 |
| Kangoo Rapid 1.2 16V | D4F 712, D4F 714 | 10.01 -> | 1,2 | 4 | 55 | M4 | ZKG1571 | 021 |
| Logan 1.4 | K7J 710 | 09.04 -> | 1,4 | 4 | 55 | M4 | ZKG15112 | 022 |
| Logan 1.4 Kombi | K7J 710 | 10.07 -> | 1,4 | 4 | 55 | M4 | ZKG15112 | 022 |
| Logan 1.6 | K7M 710 | 09.04 -> | 1,6 | 4 | 64 | M4 | ZKG15112 | 022 |
| Logan 1.6 Kombi | K7M 710 | 04.07 -> | 1,6 | 4 | 64 | M4 | ZKG15112 | 022 |
| Modus 1.2 | D4F 740 | 12.04 -> | 1,2 | 4 | 55 | M4 | ZKG1571 | 021 |
| Modus 1.2 16V | D4F 784 | 05.07 -> | 1,2 | 4 | 74 | M4 | ZKG1594 | 021 |
| Modus 1.2 16V Hi-Flex | D4F 740 | 10.08 -> | 1,2 | 4 | 55 | M4 | ZKG1571 | 021 |
| Twingo 1.2 16V | D4F 702, D4F 704 | 01.01 -> | 1,2 | 4 | 55 | M4 | ZKG1571 | 021 |
| Twingo 1.2 16V | D4F 772 | 03.07 -> | 1,2 | 4 | 56 | M4 | ZKG1571 | 021 |
| Twingo 1.2 Turbo | D4F 780 | 03.07 -> | 1,2 | 4 | 74 | M4 | ZKG1594 | 021 |

Seat

| | | | | | | | | |
|----------------|------|----------|-----|---|----|----|---------|-----|
| Alhambra 2.0 i | ADY | 04.96 -> | 2,0 | 4 | 85 | M4 | ZKG3000 | 025 |
| Altea 1.2 TSI | CBZB | 04.10 -> | 1,2 | 4 | 77 | M4 | ZKG0314 | 001 |

| Typ Type | Motornummer Engine-No. | Baujahr Year | Liter Litre | Zyl. Cyl. | KW | Vert. Distr. | BBT-Nr. BBT-No. | Abb. Pict. |
|----------------------------|---------------------------|-----------------|----------------|--------------|-----|-----------------|--------------------|---------------|
| Altea XL 1.2 TSI | CBZB | 04.10 -> | 1,2 | 4 | 77 | M4 | ZKG0314 | 001 |
| Exeo 1.6 | ALZ | 03.09 -> | 1,6 | 4 | 75 | M4 | ZKG3000 | 025 |
| Exeo 1.8 T | CFMA | 03.09 -> | 1,8 | 4 | 110 | M4 | ZKG3000 | 025 |
| Exeo ST 1.6 | ALZ | 06.09 -> | 1,6 | 4 | 75 | M4 | ZKG3000 | 025 |
| Exeo ST 1.8 T | CFMA | 06.09 -> | 1,8 | 4 | 110 | M4 | ZKG3000 | 025 |
| Ibiza V 1.2 TSI | CBZB | 09.10 -> | 1,2 | 4 | 77 | M4 | ZKG0314 | 001 |
| Ibiza V Sportcoupe 1.2 TSI | CBZB | 09.10 -> | 1,2 | 4 | 77 | M4 | ZKG0314 | 001 |
| Ibiza V ST 1.2 TSI | CBZB | 09.10 -> | 1,2 | 4 | 77 | M4 | ZKG0314 | 001 |
| Leon 1.2 TSI | CBZB | 02.10 -> | 1,2 | 4 | 77 | M4 | ZKG0314 | 001 |
| Leon 1.6 | AEH, AKL | 11.99 -> | 1,6 | 4 | 74 | M4 | ZKG0359 | 003 |
| Leon 1.6 | BSE, BSF, CCSA | 07.05 -> | 1,6 | 4 | 75 | M4 | ZKG3000 | 025 |
| Leon 1.6 LPG | CHGA | 12.09 -> | 1,6 | 4 | 75 | M4 | ZKG3000 | 025 |
| Toledo II 1.6 | AEH, AKL | 04.99 - 09.00 | 1,6 | 4 | 74 | M4 | ZKG0359 | 003 |
| Toledo III 1.6 | BGU, BSE, BSF, CCSA | 10.04 - 05.09 | 1,6 | 4 | 75 | M4 | ZKG3000 | 025 |
| Skoda | | | | | | | | |
| Fabia 1.2 TSI | CBZA | 03.10 -> | 1,2 | 4 | 63 | M4 | ZKG0314 | 001 |
| Fabia 1.2 TSI | CBZB | 03.10 -> | 1,2 | 4 | 77 | M4 | ZKG0314 | 001 |
| Octavia 1.2 TSI | CBZB | 02.10 -> | 1,2 | 4 | 77 | M4 | ZKG0314 | 001 |
| Octavia 1.6 | AEH, AKL | 02.97 -> | 1,6 | 4 | 74 | M4 | ZKG0359 | 003 |
| Octavia 1.6 | AVU, BFQ | 11.00 -> | 1,6 | 4 | 75 | M4 | ZKG3000 | 025 |
| Octavia 1.6 | BGU, BSE, BSF, CCSA | 06.04 -> | 1,6 | 4 | 74 | M4 | ZKG3000 | 025 |
| Octavia Combi 1.6 | AEH, AKL | 07.98 -> | 1,6 | 4 | 74 | M4 | ZKG0359 | 003 |
| Octavia Combi 1.6 | BGU, BSE, BSF, CCSA | 09.04 -> | 1,6 | 4 | 75 | M4 | ZKG3000 | 025 |
| Roomster 1.2 TSI | CBZA | 03.10 -> | 1,2 | 4 | 63 | M4 | ZKG0314 | 001 |
| Roomster 1.2 TSI | CBZB | 03.10 -> | 1,2 | 4 | 77 | M4 | ZKG0314 | 001 |
| Superb 2.8 V6 | AMX | 02.02 -> | 2,8 | 6 | 142 | M4 | ZKG0357 | 002 |
| Yeti 1.2 TSI | CBZB | 09.09 -> | 1,2 | 4 | 77 | M4 | ZKG0314 | 001 |
| Tata Motors | | | | | | | | |
| Indica GLX 1.4 | MPFI | 01.07 -> | 1,4 | 4 | 63 | DIN | ZKG1261 | 013 |
| Indigo SW GLX 1.4 | MPFI | 01.07 -> | 1,4 | 4 | 63 | DIN | ZKG1261 | 013 |
| Volkswagen | | | | | | | | |
| Bora 1.6 | AEH, AKL, APF | 10.98 - 05.05 | 1,6 | 4 | 74 | M4 | ZKG0359 | 003 |
| Bora 1.6 | AEH, APF | 05.99 - 05.05 | 1,6 | 4 | 74 | M4 | ZKG0359 | 003 |
| Bora 1.6 | AVU, BFQ | 08.00 - 05.05 | 1,6 | 4 | 75 | M4 | ZKG0379 | 001 |
| Caddy III 1.2 TSI | CBZA | 09.10 -> | 1,2 | 4 | 63 | M4 | ZKG0314 | 001 |
| Caddy III 1.2 TSI | CBZB | 09.10 -> | 1,2 | 4 | 77 | M4 | ZKG0314 | 001 |
| Caddy III 1.6 | BGU, BSE, BSF | 04.04 -> | 1,6 | 4 | 75 | M4 | ZKG0379 | 001 |
| Fox 1.0 | CCNA | 04.08 -> | 1,0 | 4 | 54 | M4 | ZKG0323 | 001 |
| Fox 1.0 Total Flex | CCNA | 03.08 -> | 1,0 | 4 | 54 | M4 | ZKG0323 | 001 |
| Fox 1.4 | BKR | 04.05 -> | 1,4 | 4 | 55 | M4 | ZKG0313 | 001 |
| Golf IV 1.6 | AEH, AKL, APF | 08.97 - 02.00 | 1,6 | 4 | 74 | M4 | ZKG0359 | 003 |
| Golf IV 1.6 | AVU, BFQ | 08.00 - 06.05 | 1,6 | 4 | 75 | M4 | ZKG0379 | 001 |
| Golf IV 1.6 | AVU, BSF | 05.01 -> | 1,6 | 4 | 75 | M4 | ZKG0379 | 001 |
| Golf IV Variant 1.6 | AEH, AKL, APF | 05.99 - 02.00 | 1,6 | 4 | 74 | M4 | ZKG0359 | 003 |
| Golf Plus 1.2 TSI | CBZB | 11.09 -> | 1,2 | 4 | 77 | M4 | ZKG0314 | 001 |
| Golf Plus 1.6 | BSE, BSF, CCSA | 05.05 -> | 1,6 | 4 | 75 | M4 | ZKG0379 | 001 |
| Golf Plus 1.6 MultiFuel | CCSA, CHGA | 11.07 -> | 1,6 | 4 | 75 | M4 | ZKG0379 | 001 |
| Golf V 1.6 | BGU, BSE, BSF | 01.04 -> | 1,6 | 4 | 75 | M4 | ZKG0379 | 001 |
| Golf V Plus 1.2 TSI | CBZB | 08.09 -> | 1,2 | 4 | 77 | M4 | ZKG0314 | 001 |
| Golf V Variant 1.6 | BSE, BSF, CCSA | 06.07 -> | 1,6 | 4 | 75 | M4 | ZKG0379 | 001 |
| Golf Variant 1.2 TSI | CBZA | 07.10 -> | 1,2 | 4 | 63 | M4 | ZKG0314 | 001 |

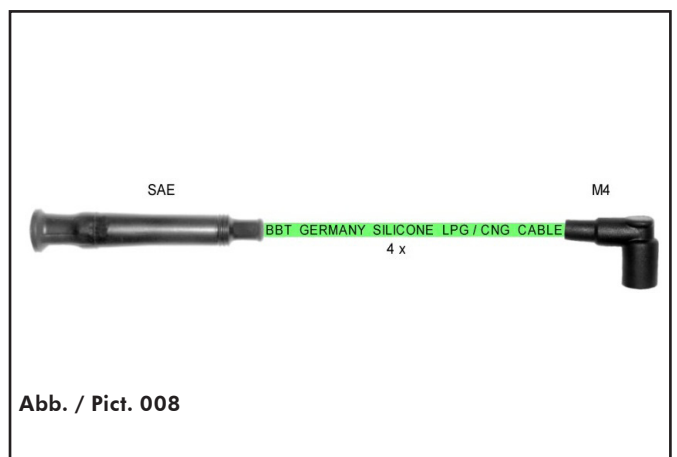
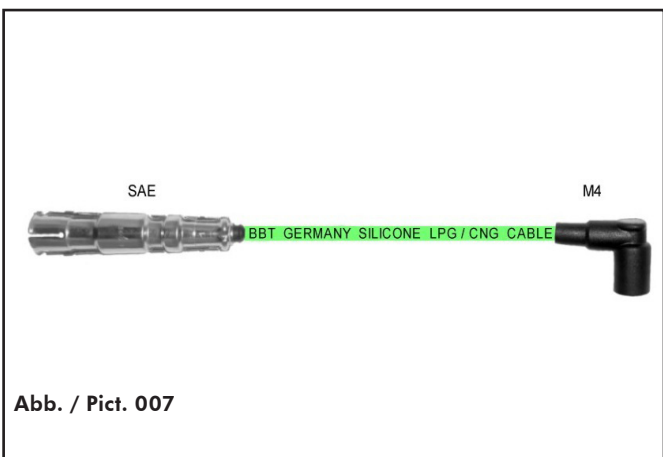
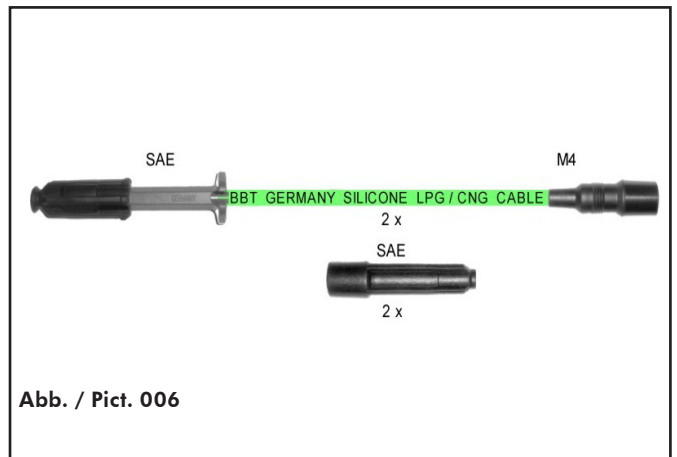
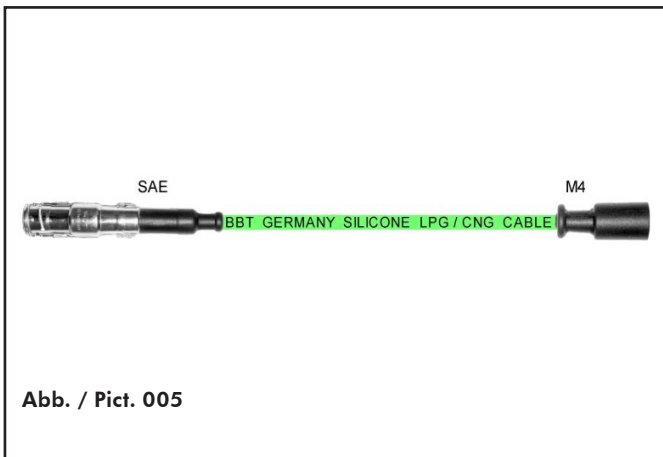
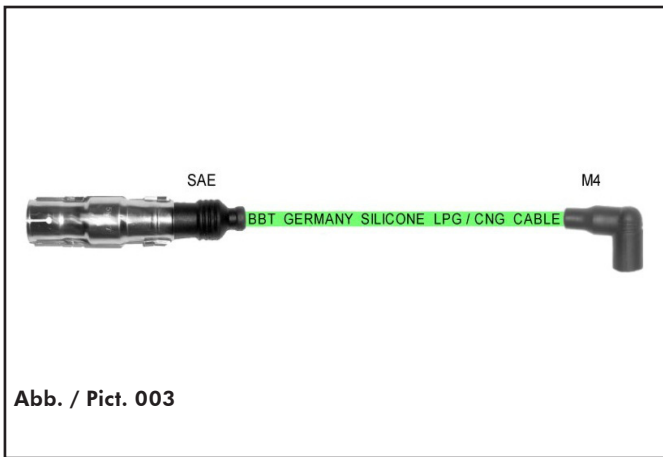
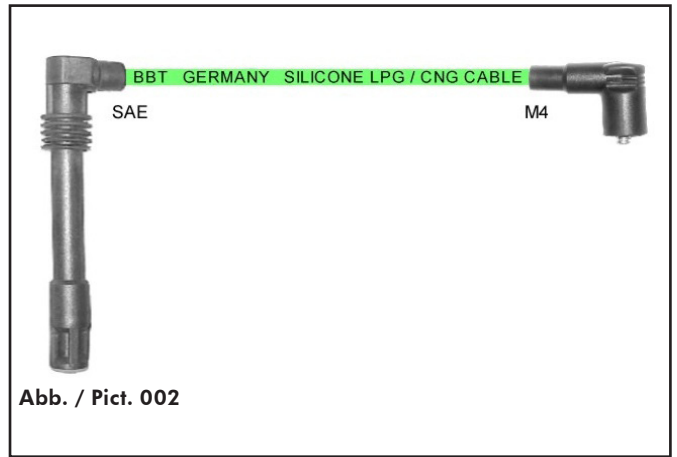
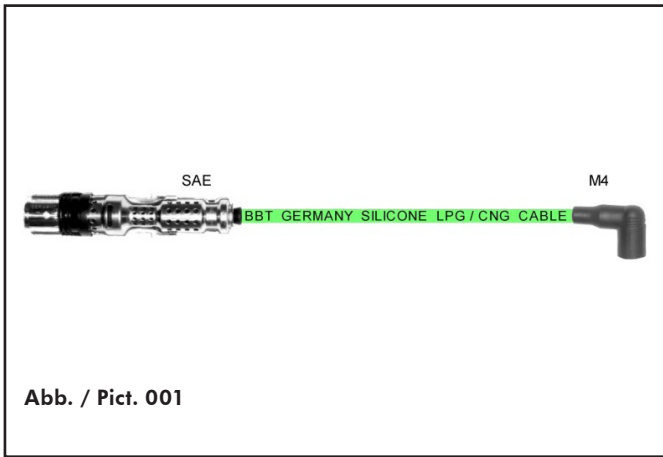

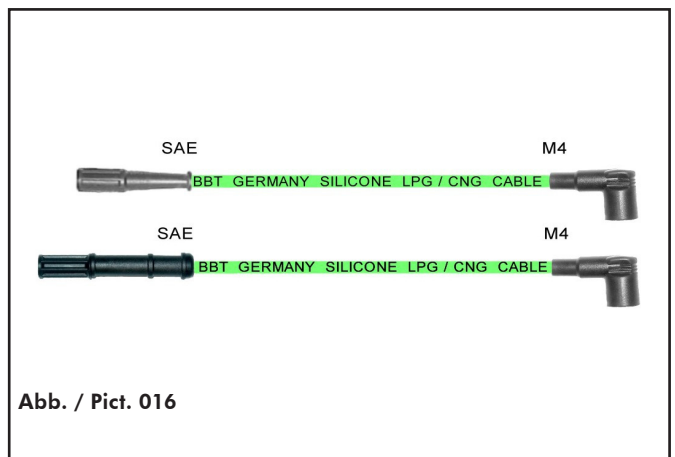
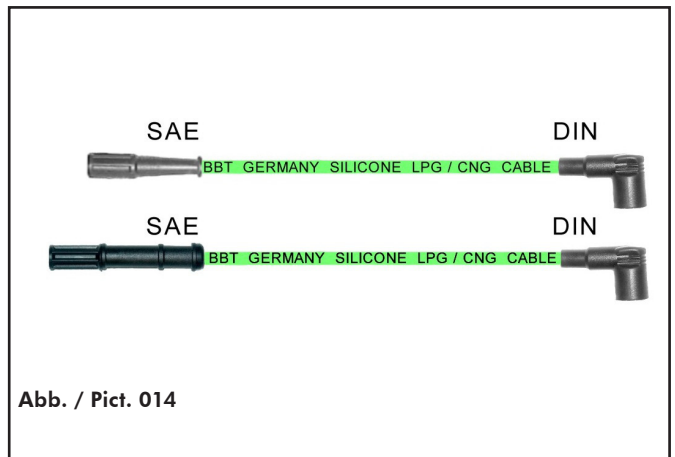
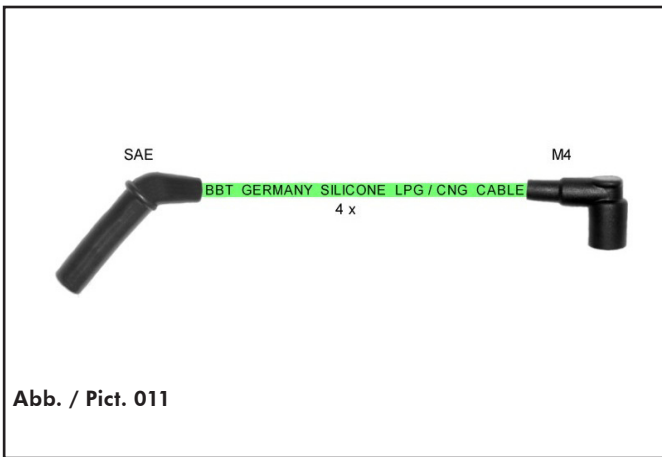
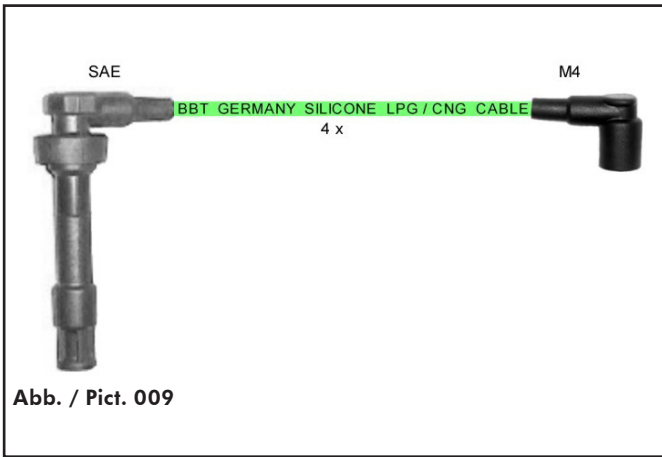

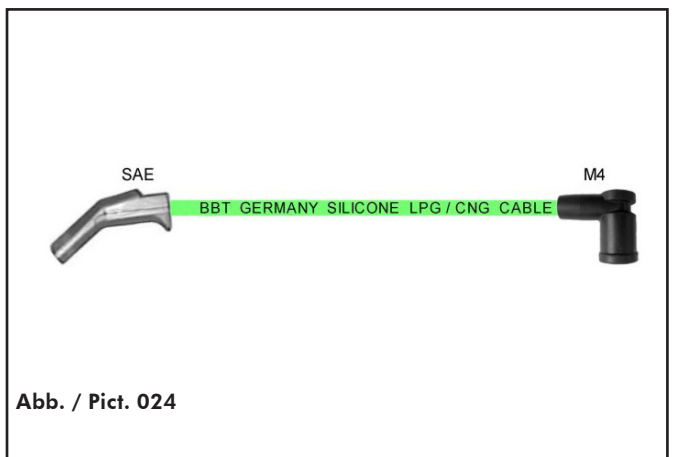
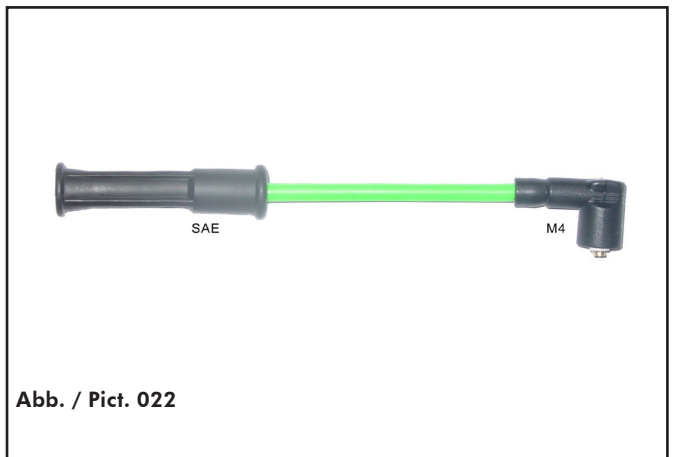
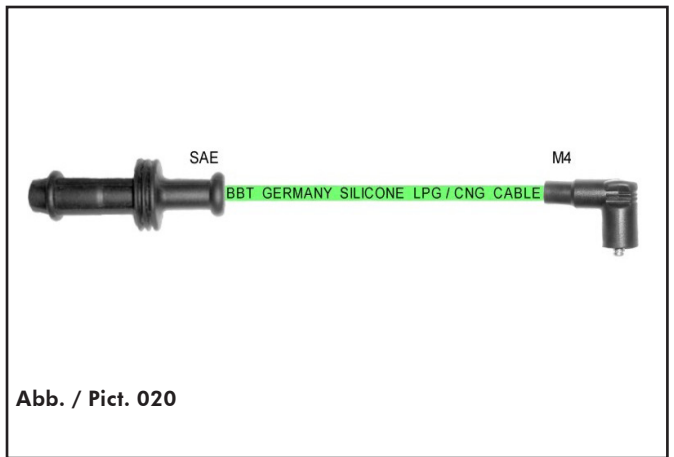
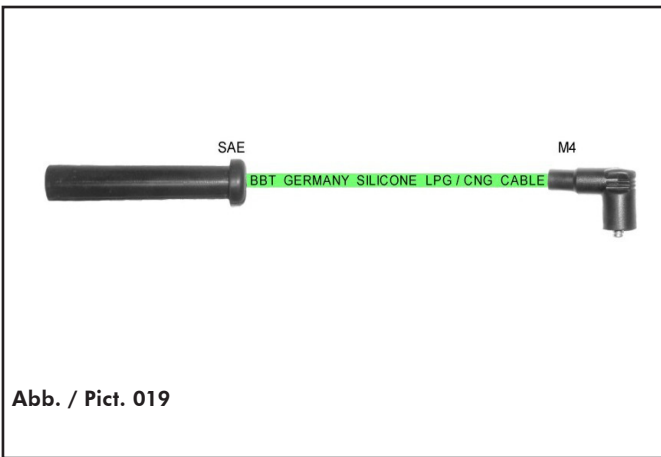
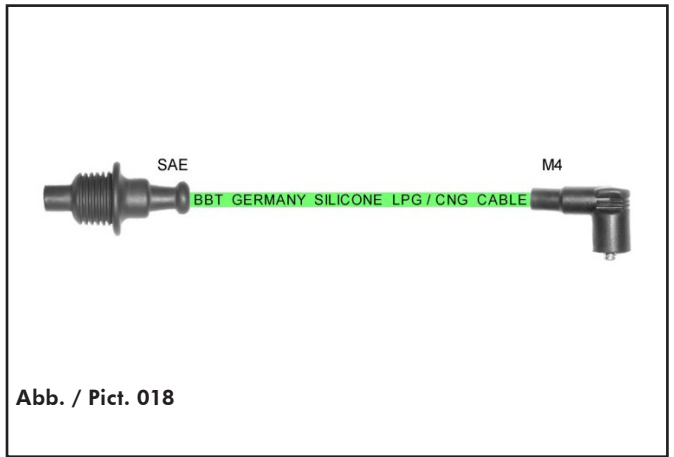

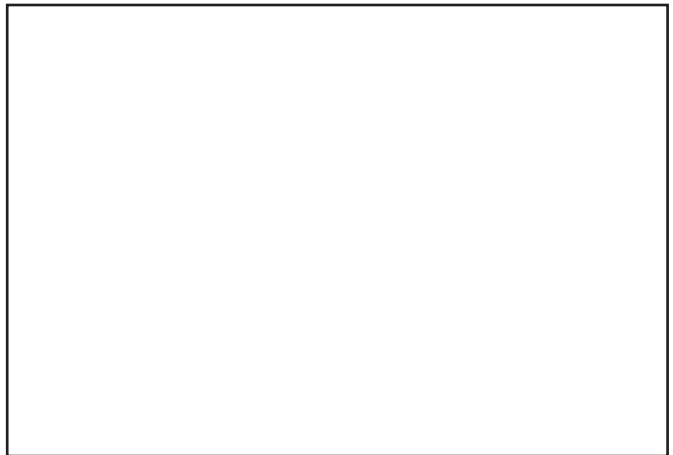
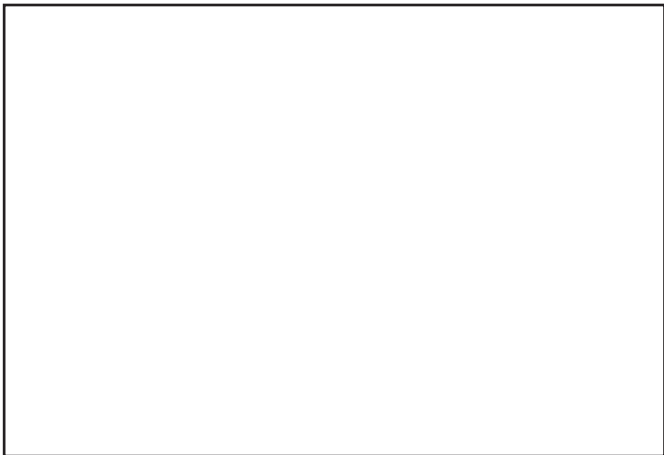
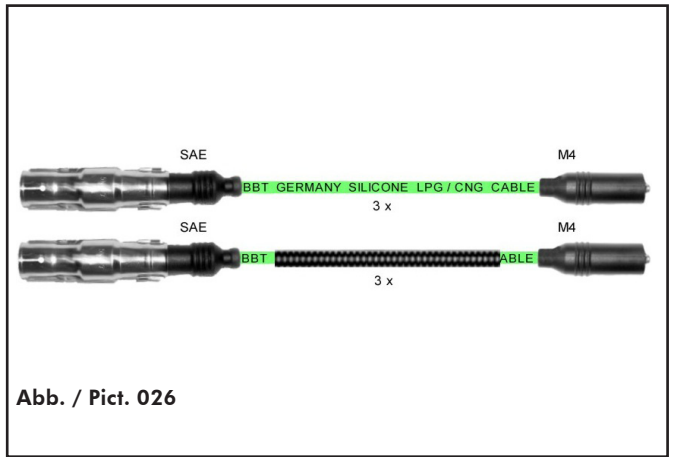

VERGLEICHSLISTE / CROSS REFERENCE LIST

| Referenz-Nr. Reference-No. | BBT-Nr. BBT-No. |
|-------------------------------|--------------------|
| Beru | BBT |
| 0 300 891 572 | ZKG0313 |
| 0 300 890 466 | ZKG0415 |
| 0 300 890 793 | ZKG1549 |
| 0 300 890 795 | ZKG1555 |
| 0 300 890 983 | ZKG1392 |
| 0 300 890 989 | ZKG0359 |
| 0 300 891 044 | ZKG1550 |
| 0 300 891 115 | ZKG1890 |
| 0 300 891 128 | ZKG1586 |
| 0 300 891 129 | ZKG1107 |
| 0 300 891 182 | ZKG0959 |
| 0 300 891 183 | ZKG0949 |
| 0 300 891 219 | ZKG0357 |
| 0 300 891 224 | ZKG3000 |
| 0 300 891 338 | ZKG0940 |
| 0 300 891 442 | ZKG0437 |
| 0 300 891 477 | ZKG1307 |
| 0 300 891 480 | ZKG1248 |
| 0 300 891 488 | ZKG0440 |
| 0 300 891 515 | ZKG0444 |
| 0 300 891 543 | ZKG1729 |
| 0 300 891 546 | ZKG15112 |
| 0 300 891 549 | ZKG1899 |
| 0 300 891 556 | ZKG0452 |
| 0 300 891 598 | ZKG1326 |
| 0 300 891 604 | ZKG1571 |
| 0 300 891 608 | ZKG1111 |
| 0 300 891 629 | ZKG0314 |
| ZEF 466 | ZKG0415 |
| ZEF 793 | ZKG1549 |
| ZEF 795 | ZKG1555 |
| ZEF 983 | ZKG1392 |
| ZEF 983 | ZKG1392 |
| ZEF 989 | ZKG0359 |
| ZEF 1044 | ZKG1550 |
| ZEF 1128 | ZKG1586 |
| ZEF 1129 | ZKG1107 |
| ZEF 1182 | ZKG0959 |
| ZEF 1183 | ZKG0949 |
| ZEF 1219 | ZKG0357 |
| ZEF 1338 | ZKG0940 |
| ZEF 1442 | ZKG0437 |
| ZEF 1477 | ZKG1307 |
| ZEF 1480 | ZKG1248 |
| ZEF 1488 | ZKG0440 |
| ZEF 1515 | ZKG0444 |
| ZEF 1540 | ZKG1729 |
| ZEF 1546 | ZKG15112 |
| ZEF 1549 | ZKG1899 |
| ZEF 1556 | ZKG0452 |

| Referenz-Nr. Reference-No. | BBT-Nr. BBT-No. |
|-------------------------------|--------------------|
| ZEF 1572 | ZKG0313 |
| ZEF 1598 | ZKG1326 |
| ZEF 1604 | ZKG1571 |
| ZEF 1608 | ZKG1111 |
| ZEF 1629 | ZKG0314 |
| BMW | BBT |
| 12 12 1 247 512 | ZKG0959 |
| 12 12 1 247 513 | ZKG0959 |
| 12 12 1 247 523 | ZKG0959 |
| 12 12 1 247 526 | ZKG0959 |
| 12 12 1 709 206 | ZKG0940 |
| 12 12 1 709 207 | ZKG0940 |
| 12 12 1 709 208 | ZKG0940 |
| 12 12 1 709 209 | ZKG0940 |
| Bosch | BMW |
| 0 986 356 310 | ZKG0940 |
| 0 986 356 321 | ZKG0357 |
| 0 986 356 333 | ZKG0415 |
| 0 986 356 346 | ZKG0379 |
| 0 986 356 359 | ZKG0359 |
| 0 986 356 361 | ZKG0949 |
| 0 986 356 390 | ZKG3000 |
| 0 986 356 727 | ZKG1550 |
| 0 986 356 767 | ZKG1549 |
| 0 986 356 787 | ZKG1392 |
| 0 986 356 830 | ZKG1555 |
| 0 986 356 987 | ZKG1107 |
| 0 986 357 141 | ZKG1890 |
| 0 986 357 267 | ZKG1898 |
| 0 986 357 285 | ZKG1111 |
| 0 986 357 287 | ZKG1729 |
| Chevrolet | BBT |
| 96 288 956 | ZKG1111 |
| Citroën | BBT |
| 5967 L0 | ZKG1549 |
| 5967 L3 | ZKG1550 |
| 5967 L5 | ZKG1555 |
| 5967 L6 | ZKG1550 |
| 5967 L7 | ZKG1549 |
| 5967 L8 | ZKG1550 |
| 5967 L9 | ZKG1555 |
| 5967 N1 | ZKG1550 |
| 5967 N6 | ZKG1555 |
| 9609 493 380 | ZKG1549 |
| Dacia | BBT |

| Referenz-Nr. Reference-No. | BBT-Nr. BBT-No. |
|-------------------------------|--------------------|
| 77 00 273 826 | ZKG1586 |
| 82 00 506 297 | ZKG15112 |
| Daewoo | BBT |
| 96 211 948 | ZKG1107 |
| 96 288 956 | ZKG1111 |
| Fiat | BBT |
| 7776810 | ZKG1322 |
| 46413088 | ZKG1392 |
| 46749624 | ZKG1307 |
| 55195775 | ZKG1326 |
| 55195776 | ZKG1326 |
| Ford | BBT |
| 1335369 | ZKG1899 |
| 1335371 | ZKG1899 |
| 1335374 | ZKG1899 |
| 1335377 | ZKG1899 |
| Mazda | BBT |
| 1E05 18 160 B | ZKG1729 |
| 1E05 18 170 B | ZKG1729 |
| 1E05 18 180 B | ZKG1729 |
| 1E05 18 190 B | ZKG1729 |
| Mercedes | BBT |
| 102 150 19 18 | ZKG0415 |
| 102 150 20 18 | ZKG0415 |
| 102 150 21 18 | ZKG0415 |
| 102 150 28 18 | ZKG0415 |
| 102 150 29 18 | ZKG0415 |
| 112 150 01 18 | ZKG0437 |
| 112 150 02 18 | ZKG0437 |
| 112 150 03 18 | ZKG0440 |
| 112 150 04 18 | ZKG0440 |
| 266 150 02 18 | ZKG0452 |
| 266 150 06 18 | ZKG0452 |
| 266 150 07 18 | ZKG0452 |
| A 112 150 01 18 | ZKG0437 |
| A 112 150 02 18 | ZKG0437 |
| A 112 150 03 18 | ZKG0440 |
| A 112 150 04 18 | ZKG0440 |
| A 266 150 02 18 | ZKG0452 |
| A 266 150 06 18 | ZKG0452 |
| A 266 150 07 18 | ZKG0452 |
| Mini | BBT |
| 12 12 7 513 032 - 035 | ZKG1248 |

